

# FORMAX<sup>®</sup>

---

FD 38Xi / FD 386  
Document Folder

OPERATOR MANUAL  
FIRST EDITION



# **TABLE OF CONTENTS**

<b>SUBJECT</b>	<b>PAGE</b>
DESCRIPTION	1
SPECIFICATION	1
UNPACKING & SETUP	2
CONTROL PANEL	4
OPERATION	5
AutoBatch BATCH COUNTING	7
FD 386 CUSTOM FOLD SETUP	8
FD 38Xi CUSTOM FOLD SETUP	10
MEASURING FOLD LENGTHS	13
RECALLING, EDITING, & DELETING CUSTOM FOLDS	14
OPERATOR SETTINGS	16 - 18
Metric/Standard Fold Selection	16
Standard Fold Override	16
Test Sheet Setting	18
Default Settings	18
MULTI-SHEET FEEDING	19
CROSS FOLDING	20
FD 386 STACKER WHEEL POSITIONING CHART	20
REMOVING INFEED TIRES	21
OPERATOR MAINTENANCE	22
ERROR SCREENS	23
TROUBLE SHOOTING	24





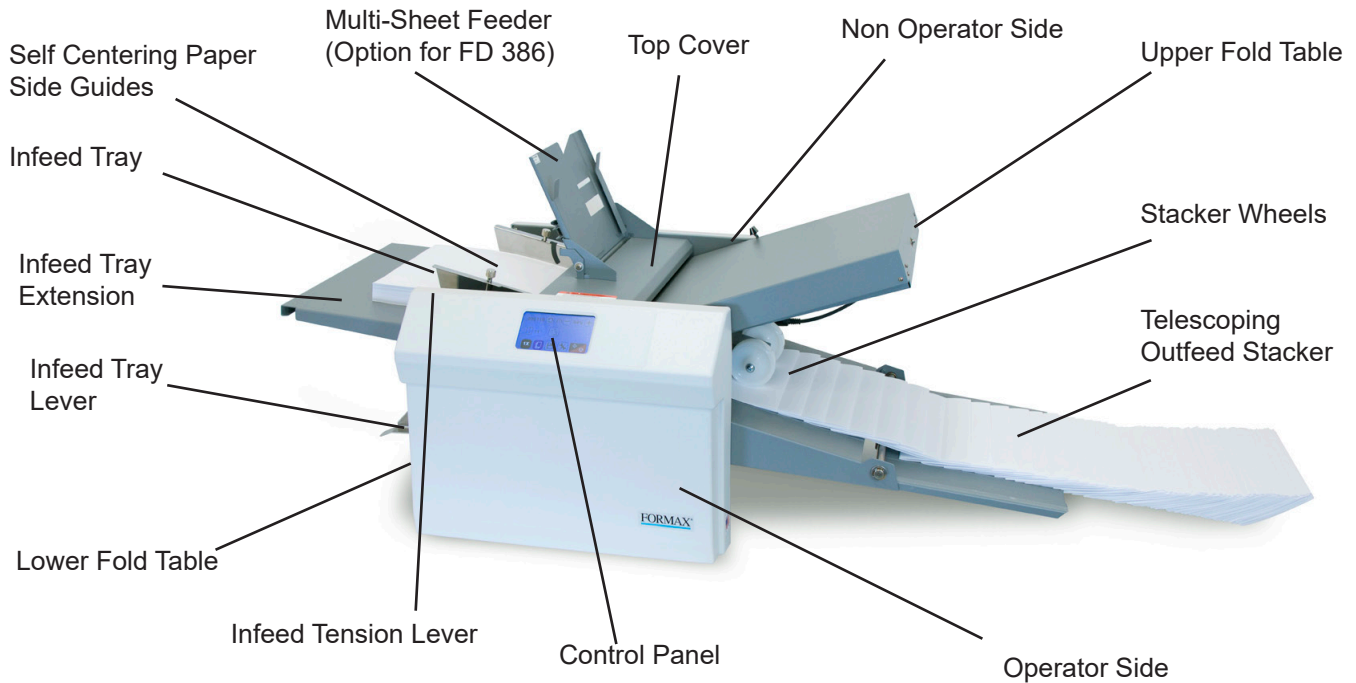



# DESCRIPTION



The FD 38Xi / FD 386 Folder is designed to perform a wide variety of folds using a variety of paper weights. The fold tables are automatically adjusted for standard folds and custom folds. Documents that are 8 ½" x 11"/14" and 11" x 17" (A5, A4, A3, B4, B5 & B6) are detected by sensors on the infeed tray. Batch counting, self-centering side guides, and the capability to cross-fold are added features. There are six pre-programmed standard folds and up to 35 (FD 38Xi) or 27 (FD 386) custom folds available. The folder will automatically stop after the last document has been folded.

# SPECIFICATIONS

Speed:	Standard Mode: Up to 16,450/hour, depending on fold type
Hopper Capacity:	Up to 500 sheets of 20# paper (75gsm)
Paper size:	Min: 3.5" X 5" (88.9 W x 127 L mm) Max: 12.25" X 18" (311 W x 457 L mm)
Pre programmed fold types:	Letter  , Zig-Zag  , Single  , Gate  , Fold Out  , Double Parallel 
Custom Fold Settings:	27 (FD 386), 36 (FD 38Xi)
Pre-Set Paper Sizes:	11", 14", 17", A5, A4, A3, B6, B5, B4
Dimensions	Closed: 33" L x 20" W x 19" H (84 L x 51 W x 48 H cm) Fully Extended: 60" L x 20" W x 19" H (152 L x 51 W x 48 H cm)
Weight:	74 lbs (34 kg)
Power:	110V - 240V AC, 50/60 Hz, 2 amps.
Safety Certifications:	UL & CE Applied For

# UNPACKING & SETUP

1. Check package for shipping damage. If there is shipping damage, do not discard the box.
2. Remove the machine and packed components from the box. The fold tables, telescoping stacker, Multi Sheet Feeder (standard feature FD 38Xi, option for FD 386), power cord and cross-fold guide are wrapped separately in the box.

**NOTE:** Two people must lift the machine from the box.

3. Place the folder on a solid stand.

## Install upper and lower fold tables, telescoping conveyor multi-sheet feeder and power cord

1. Be sure the plates are set firmly on the locating pins (Fig 1a & 1b). Slide each fold table in until it meets the first locating pin then push down to set in place.

Upper Fold Table Pins



Fig. 1a

Locating Pins

Lower Fold Table Pins

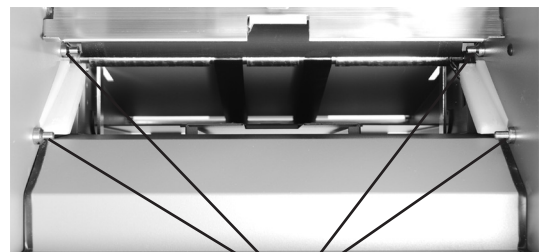

Fig. 1b

Locating Pins

2. Lock the fold table into position (FD 38Xi Only) (Fig. 2)
3. Repeat the same steps for the lower fold table.

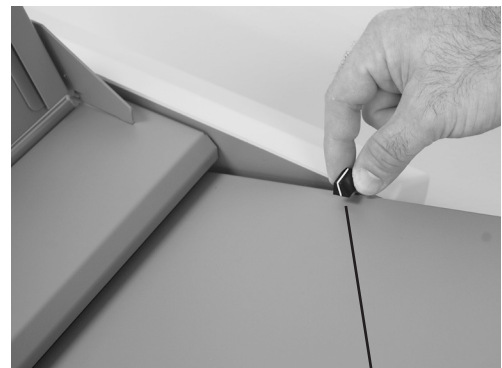

Fig. 2

Fold Table Lock

4. Plug the fold table cables into the receptacles on the side frame (Fig. 3a & 3b).

Upper Fold Table Receptacle Location

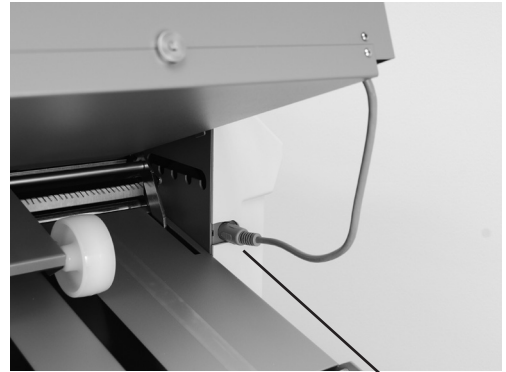

Fig. 3a

Plug in Receptacle

Lower Fold Table Receptacle Location



Fig. 3b

Plug in Receptacle

5. Insert the telescoping extension tray into the end of the outfeed conveyor (Fig. 4).

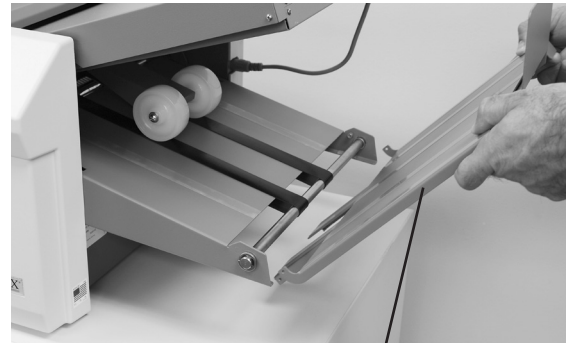

Fig. 4

Telescoping extension tray

6. Insert the Multi-Sheet Feeder into the four slots located on the top cover (Fig 5). This is standard on the FD 38Xi, optional for the FD 386.
7. Make sure the power switch is in the "OFF" position. Plug the power cord into the power inlet and the wall outlet.



Fig. 5

4 Slots

# CONTROL PANEL - Home Screen Interface

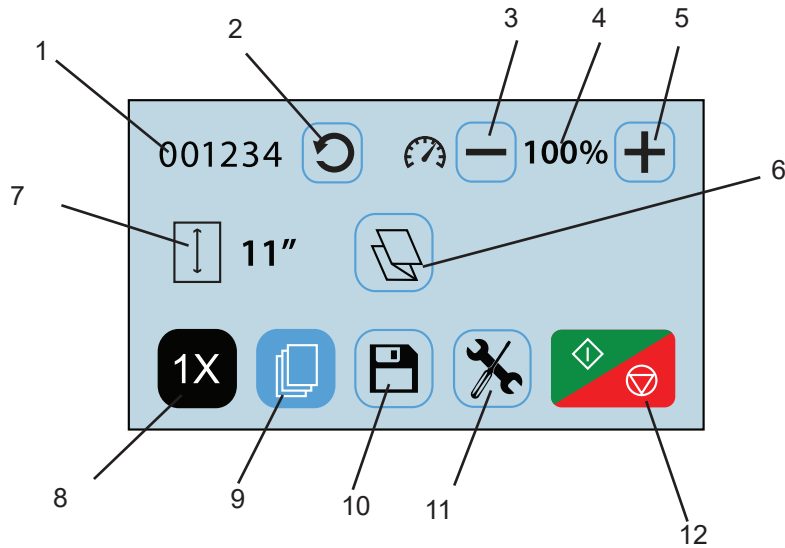

No.	NAME	FUNCTION
1	Resettable Counter	Displays the number of documents folded, can be reset between each job
2	Counter Reset Icon	Resets the counter to "0"
3	Speed Decrease Icon	Press to decrease the folder speed
4	Speed Level Display	Folder speed percentage
5	Speed Increase Icon	Press to increase the folder speed
6	Fold Selection Icon	Press to advance to fold selection screen
7	Paper Size Display	Shows the size of the paper in the folder
8	1X Fold Test Icon	Press to test the fold selected
9	AutoBatch Mode	Press to enter AutoBatch mode
10	Custom Fold Access	Press to select or edit previously saved custom folds
11	Operator Settings Icon	Press to enter to the operator settings screen
12	Start / Stop Icon	Press to start the folder. Press to stop the folder

Any icon with a blue frame around it (i.e. #2 above) can be adjusted by pressing the icon. Icons without a blue frame (i.e. #4 above) provide status, and cannot be pressed.

In any other screens, use the  icon after choosing a setting or entering information.

To return to the home screen from any other screen, press the  home icon.



# OPERATION

1. Place power switch in the ON / "I" position.
2. Extend the catch tray as required.
3. FD 386 ONLY: Move the stacker wheels to the proper position for the paper size (Fig. 6) (Refer to chart below). *Stacker wheels will automatically adjust on the FD 38Xi.*

	8.5" x 11"	8.5" x 14"	11" x 17"
<b>Letter</b>	A	A or B	B
<b>Zig-Zag</b>	A	A or B	B
<b>Single</b>	B	B	C
<b>Gate</b>	A	B	C
<b>Fold Out</b>	B	C	C
<b>Double II</b>	A	A	A or B

Stacker Wheel Positions A, B & C

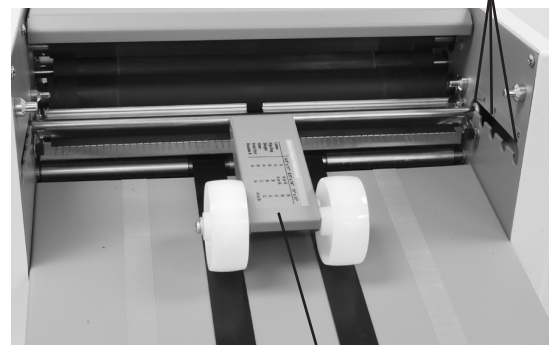

Fig. 6

Stacker Wheels

4. Set the self-centering paper side guides for the width of the paper and lock in position using thumbscrews. Place a single sheet of paper between the guides and move them in or out, until the paper slides freely between them.

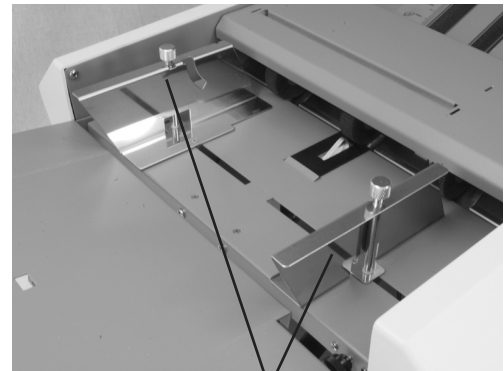

Fig. 7

Self centering side guides

5. FD 38Xi ONLY: Adjust infeed tray tension lever (Fig. 8) for different paper weights. Move the lever up towards the "-" symbol for lighter paper and down toward the "+" symbol for heavier paper. The middle position is for standard paper weights.



Operator side

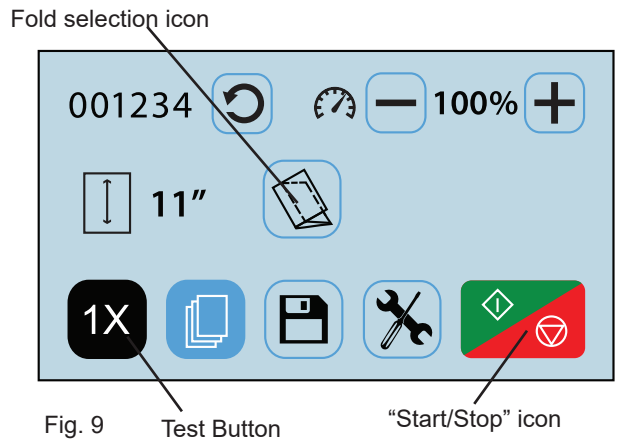



Fig. 8

Tension Lever

6. Raise the infeed tray lever to lower the infeed tray.
7. Neatly stack paper on the infeed tray.
8. Lower the infeed tray lever to raise the infeed tray.

- Select the type of fold desired by pressing the fold selection icon  (Fig. 9). Note: *If the fold selection icon shows the desired fold press the “Start/Stop” icon  (Fig. 9) to begin folding.*



- Select the standard fold type needed (Fig. 10) and press the “Enter” icon  to set the fold stop positions. When the fold stops are set the folder will return to the home screen. The selected fold icon should now be displayed.

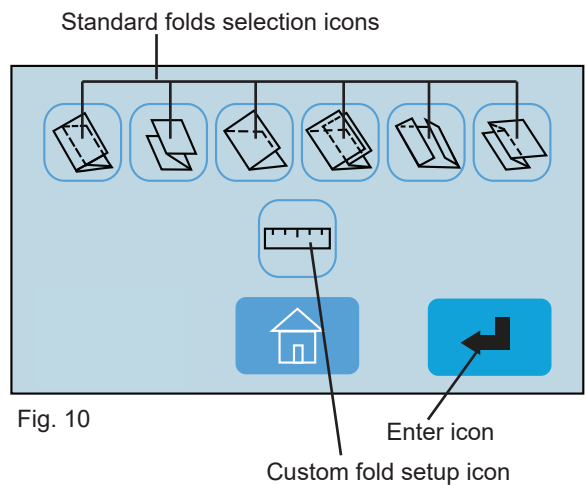

Press the test icon  to check the fold.

- If the fold is skewed, remove paper, lower the infeed tray extension and turn the skew adjustment knob left or right to make corrections (Fig. 11).

Press the test icon  to check the fold.

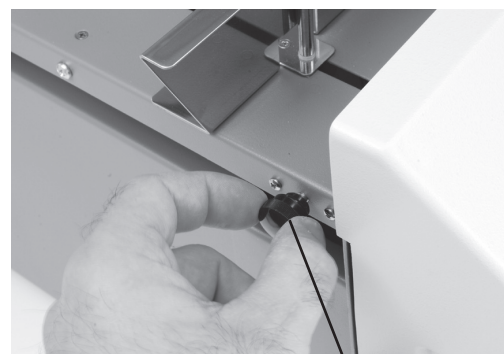







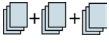

- When satisfied with the test fold, press the “Start/Stop” icon  to begin folding. Press the same icon to stop.

- Press the “-” or “+” icons (Fig. 9) to adjust machine speed to desired level.

# AUTOBATCH COUNTING MODE

The AutoBatch feature can be set to count down the number of sets in a batch, the number of sheets in each set, and the delay between each set. To enter the AutoBatch Mode press the  icon on the main screen (Fig. 12a).

1. To enter the number of sets press the  icon (fig. 12b). Enter the number of sets on the keypad that appears. Next press the  icon to select the number of sheets, and then press the  icon to enter the delay between sets. Press the  to exit the keypad (Fig. 12c).
2. Press the  icon to begin folding. The folder will stop when the number of sets counts down to zero (0).
3. To exit the AutoBatch Mode press the  icon.

Note: Press the  icon on the keypad to exit back to the Auto Batch screen. Press the  icon to edit the number entered. Press the  icon on the keypad to reset the entered number to zero (0).

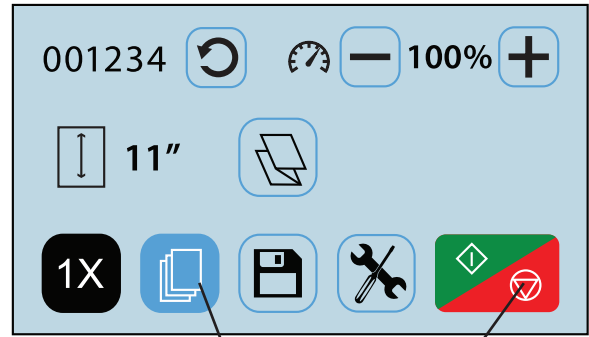

Fig. 12a  
AutoBatch Mode  
"Start/Stop" icon

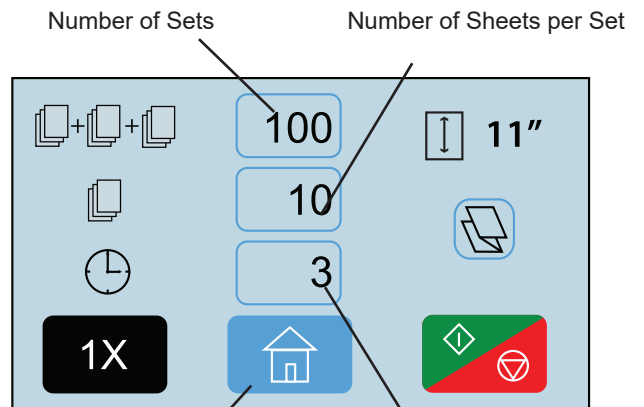

Fig. 12b  
Number of Sets  
Number of Sheets per Set  
Delay between sets (seconds)  
Return to Home Screen

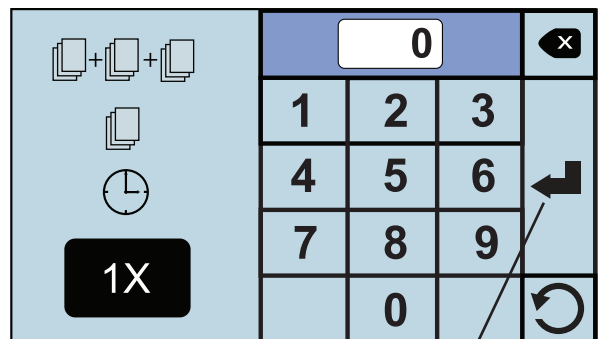



Fig. 12c  
Exit icon

# FD 386 CUSTOM FOLDS SETUP

The FD 386 has 27 custom fold settings that can be stored into memory for recurring jobs with fold settings that differ from standard fold settings. To create a custom fold, from the Home Screen (Fig. 13) press the fold selection icon  to access the fold selection screen (Fig. 14) From the fold selection screen press the Custom Fold icon . See page 13 to help determine the new fold measurements.

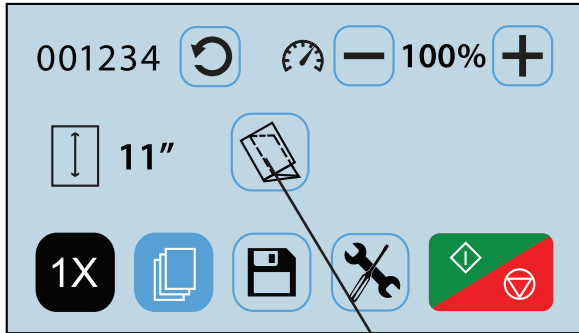

Fig. 13 Fold Selection icon

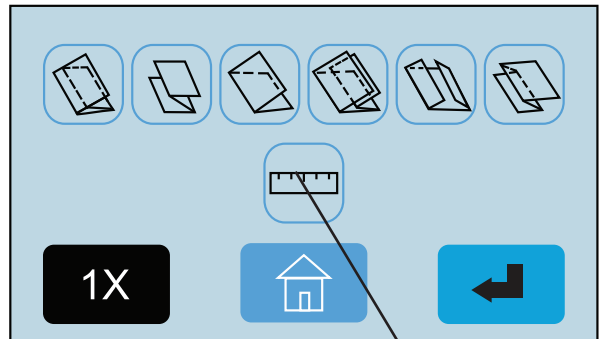



Fig. 14 Custom Fold icon

1. Select the top fold plate icon  (Fig. 15) to set the fold stop position for the first fold (the icon will flash dark gray when selected). Using the touch pad, key in the measurement for the first fold stop position. (**Note:** the minimum position is 1.62" and the max. position is 12.59".).

Press the enter key  to enter the measurement . The white box under the icon will show the measurement entered. (Fig. 16)

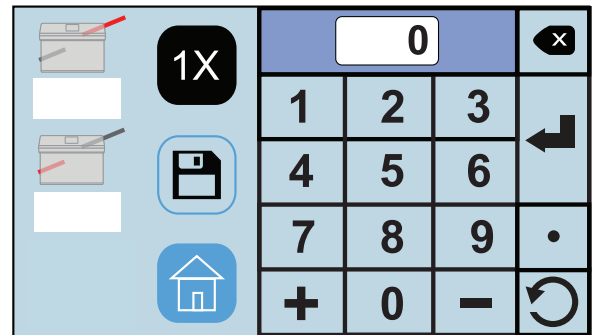



Fig. 15

2. Select the lower fold plate icon  (Fig. 16) to set the fold stop position for the second fold (the icon will flash dark gray when selected). Using the touch pad, key in the measurement for the second fold stop position, (**Note:** the minimum position is 1.49" and the max. position is 8.40".).

Press the enter key  to enter the measurement . The white box under the icon will show the measurement entered.

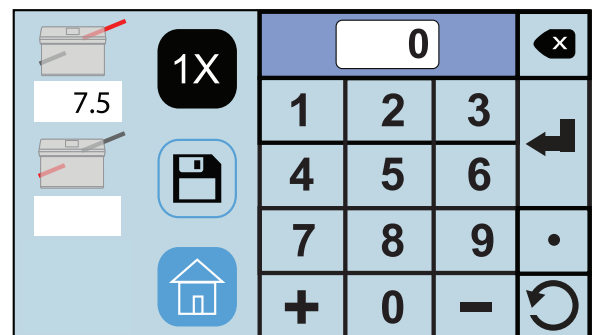



Fig. 16

Leave the second fold stop position at Zero for Half Fold.

- With paper loaded in the feeder press the test icon  (Fig. 17) to check that the fold settings are correct. To adjust the settings repeat steps 1 and 2.

When the folds are set correctly press the save icon  to name and save the custom fold. Press the green box with the check to continue or the red box with the X to exit and return to the measurement screen.

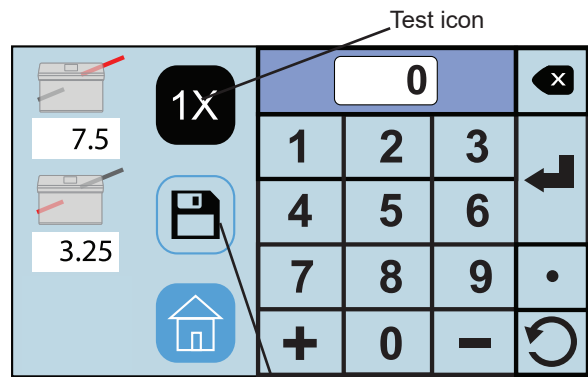



Fig. 17

- Select the job number the fold will be saved as (Fig. 18). Press the letter icon  to bring up the keypad to name the custom fold.

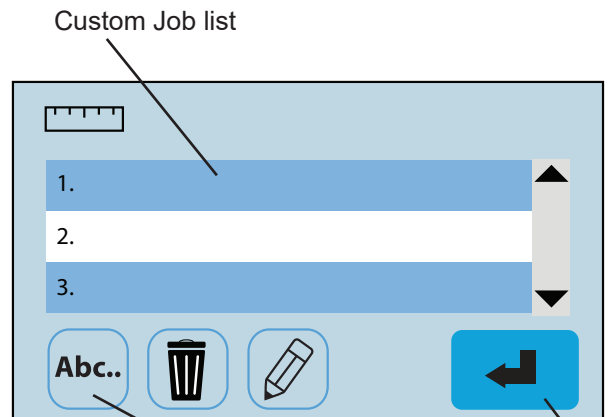

Fig. 18

- Key in the name of the job and press the save icon in the bottom right corner (Fig. 19).

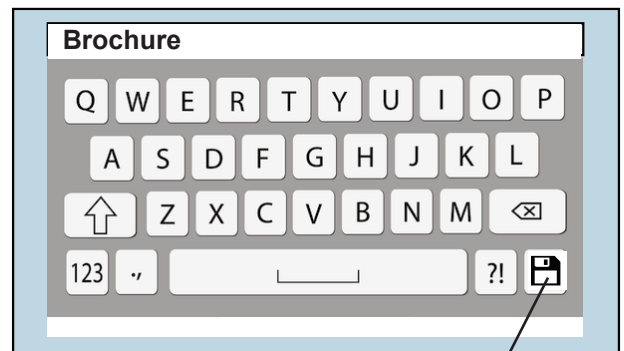



Fig. 19

- Select the custom job and press the blue enter icon  to set the fold stops (Fig. 20). When the fold stops are set, the folder will return to the Home Screen with the custom job selected.

Press the start icon  to begin folding.

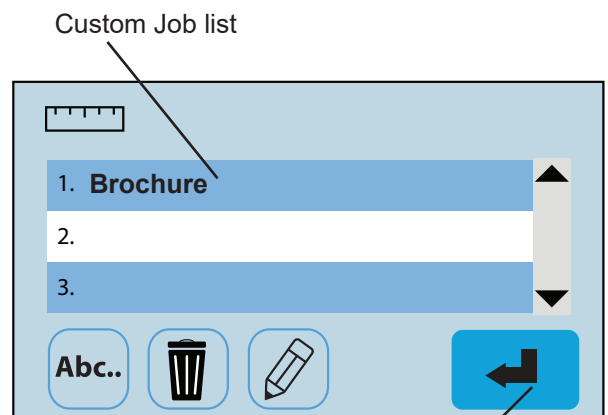



Fig. 20

# FD 38Xi CUSTOM FOLDS SETUP

The FD 38Xi has 36 custom fold settings that can be stored into memory for recurring jobs with fold settings that differ from the standard fold settings. To create a custom fold, from the Home Screen press the fold selection icon  to access the fold selection screen (Fig. 9) From the fold selection screen press the Custom Fold icon . See page 13 to help determine the new fold measurements.

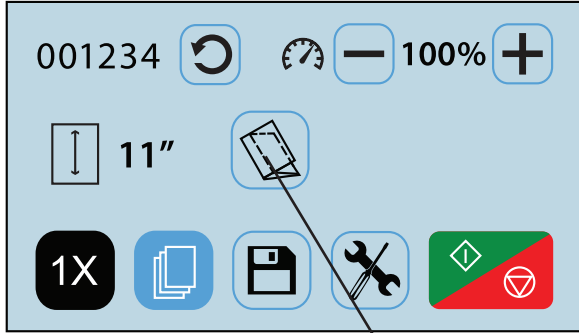

Fig. 21 Fold Selection icon

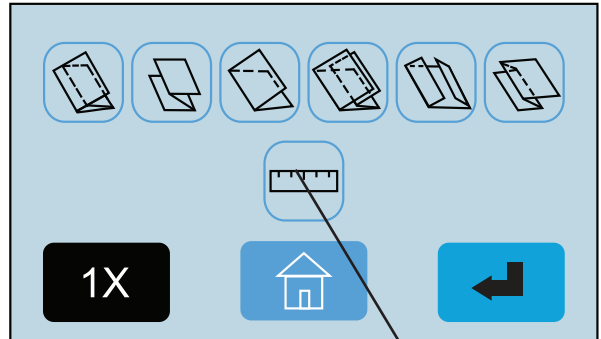



Fig. 22 Custom Fold icon

1. Select the top fold plate icon  (Fig. 23) to set the fold stop position for the first fold (the icon will flash dark gray when selected). Using the touch pad key, in the measurement for the first fold stop position, (**Note:** the minimum position is 1.62" and the max. position is 12.59".).

Press the enter key  to enter the measurement . The white box under the icon will show the measurement entered (Fig. 24).

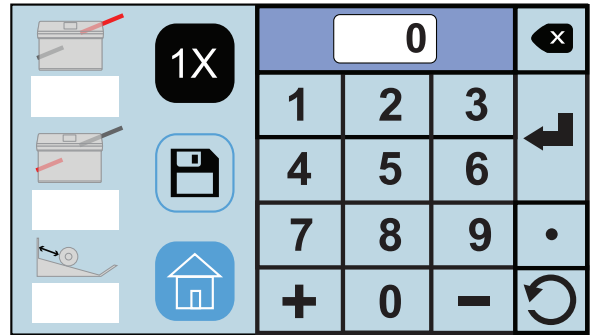



Fig. 23

2. Select the lower fold plate icon  (Fig. 24) to set the fold stop position for the second fold (the icon will flash dark gray when selected). Using the touch pad, key in the measurement for the second fold stop position, (**Note:** the minimum position is 1.49" and the max. position is 8.40".).

Press the enter key  to enter the measurement . The white box under the icon will show the measurement entered.

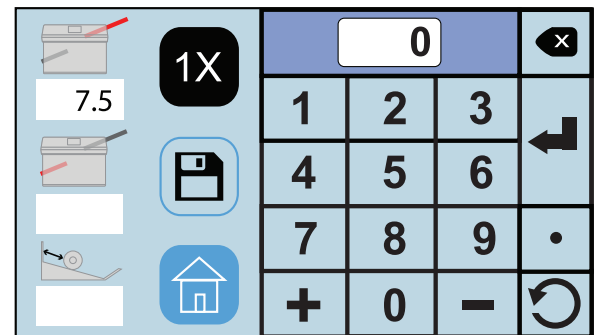



Fig. 24

Leave the fold stop position at Zero for Half Fold.

## FD 38Xi CUSTOM FOLDS SETUP, cont.

5. Next set the automatic outfeed stackers. There are 10 stacker positions available. Select the one that best matches the size of the folded document. Using the touch pad key in the stacker position (Fig. 25), key in 0 - 9 based on the chart below.

Press the enter key  to enter the position. The white box under the icon will show the position entered. (Fig. 26).

### Stacker Wheel Positions:

- |   |                                   |
|---|-----------------------------------|
| 0 | Folded size to: 3.75"             |
| 1 | Folded size to: 4.00"             |
| 2 | Folded size to: 4.43"             |
| 3 | Folded size to: 4.87"             |
| 4 | Folded size to: 5.30"             |
| 5 | Folded size to: 5.73"             |
| 6 | Folded size to: 6.16"             |
| 7 | Folded size to: 6.60"             |
| 8 | Folded size to: 7.03"             |
| 9 | Folded size to: 7.46" and greater |

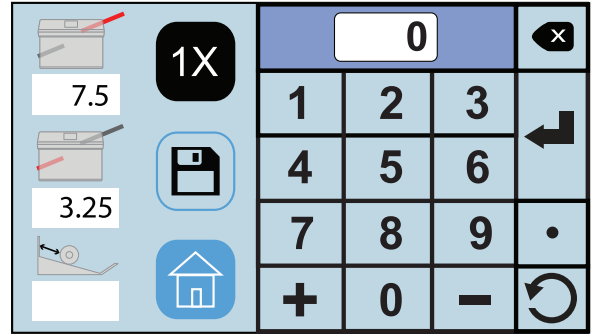



Fig. 25

4. With paper loaded in the feeder press the test icon  (Fig. 26) to check that the fold settings are correct. To adjust the settings repeat steps 1 - 3.

When the folds and stacker wheels are set correctly press the save icon  to name and save the custom fold.

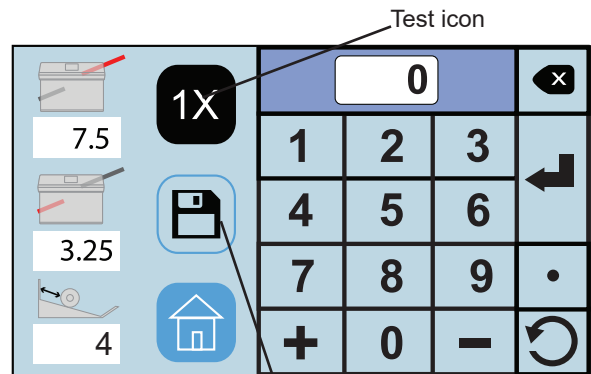



Fig. 26

5. Select the job number the fold will be saved as (Fig. 27). Press the letter icon  to bring up the keypad to name the custom fold.

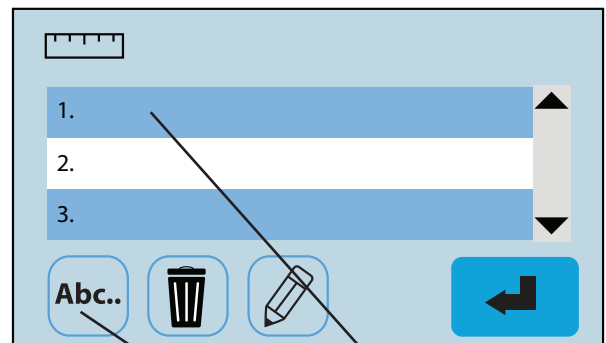

Fig. 27

Letter icon

Custom Job list

## FD 38Xi CUSTOM FOLDS SETUP, cont.

5. Key in the name of the job (Fig. 28) and press the save icon in the bottom right corner.

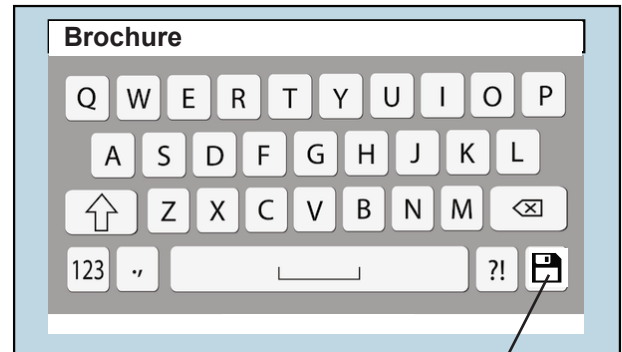



Fig. 28

Save icon

6. Select the custom job and press the blue enter icon  to set the fold stops (Fig. 29).

When the fold stops are set, the folder will return to the Home Screen with the custom job selected.

Press the start icon  to begin folding.

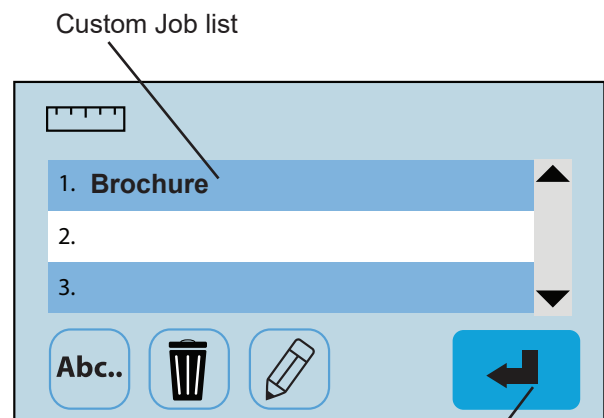

Fig. 29

Enter Icon



## Measuring Fold Lengths

Use the examples below to help determine the fold lengths for custom fold settings.

### Example 1: “Z” Fold

1. Measure the length of panel “A”, enter this number as the upper fold table measurement.
2. Measure the length of panel “B”, enter this number as the lower fold table measurement.

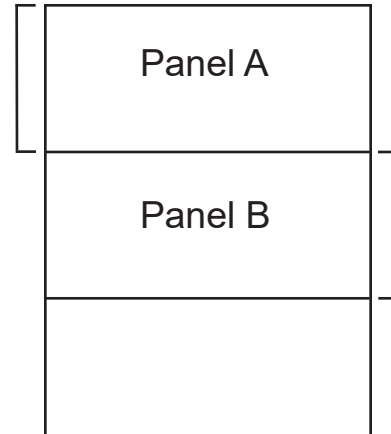

### Example 2: “C” Fold

1. Measure the length of panel “A” + “B”, enter this number as the upper fold table measurement.
2. Measure the length of panel “B”, enter this number as the lower fold table measurement.

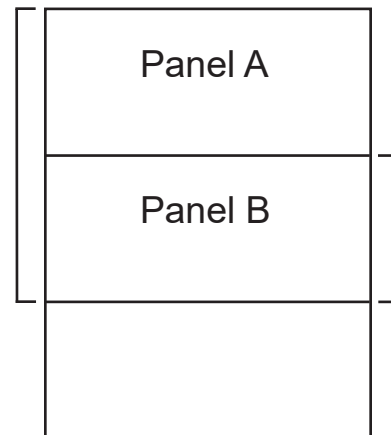

# RECALLING, EDITING & DELETING SAVED CUSTOM FOLDS SETUP

1. To recall, edit, or delete a saved custom fold from the home screen press the saved job icon  (Fig. 30).

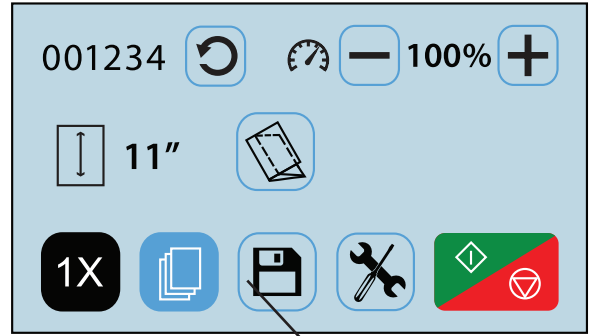



Fig. 30

2. From the saved custom job screen you can recall a job, edit, rename, or delete a stored custom fold.

To recall select the job from the list and press the blue enter button  (Fig. 31). The fold will be set and then will return to the home screen to start processing the job.

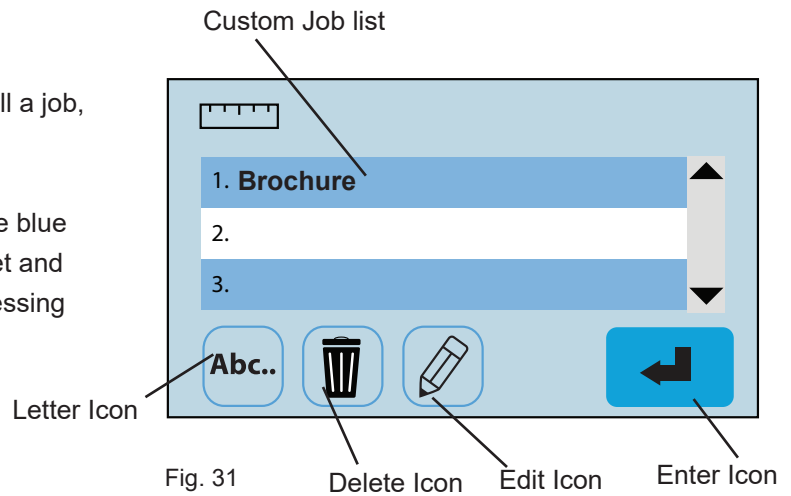



Fig. 31

3. To rename a job, select the job from the list and press the letter icon  (Fig. 31). Use the keypad to change the name and press the save icon in the lower right corner (Fig. 32).

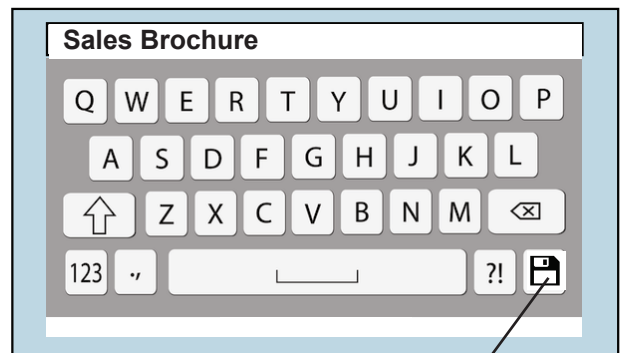



Fig. 32

4. To delete a job, select the job from the list and press the delete icon  (Fig. 31). On the confirmation screen press the green box with the check to confirm the deletion or press the red box with the X to cancel the deletion (Fig. 33).

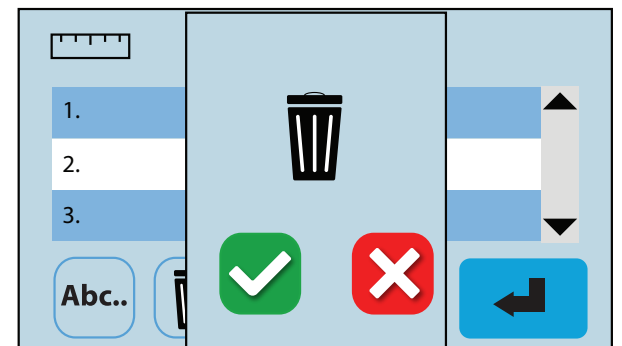



Fig. 33

Deletion confirmation screen

# RECALLING, EDITING & DELETING SAVED CUSTOM FOLDS SETUP

- To edit a previously saved job, select the job from the list and press the edit icon  (Fig. 31). From the fold setup screen use the same process as setting a custom fold to edit the job settings (Fig. 34). See page 13 for measuring guidelines.

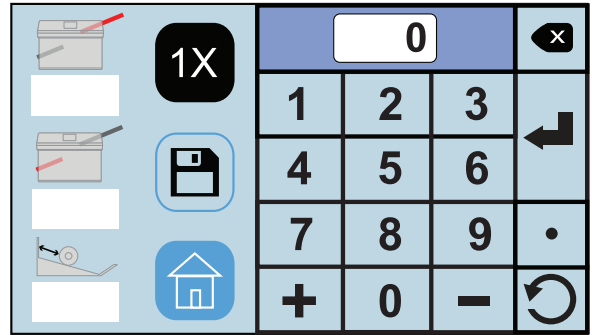



Fig. 34

# OPERATOR SETTINGS

A number of operator settings can be adjusted to personalize the FD 386 / FD 38Xi. This includes changing between standard and metric settings, number of test sheets, Fold and Stacker Override, and Standard Fold Override. This section will review each setting and how to adjust them. If needed, there is a Default Settings option that will reset to factory settings. To advance to the Operator Settings Screen press the Tool icon  on the Home screen.

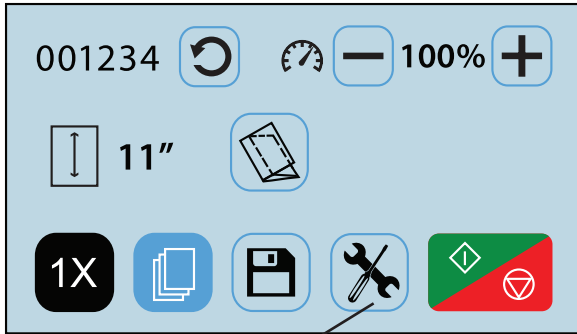

Fig. 35

Operator Settings Icon

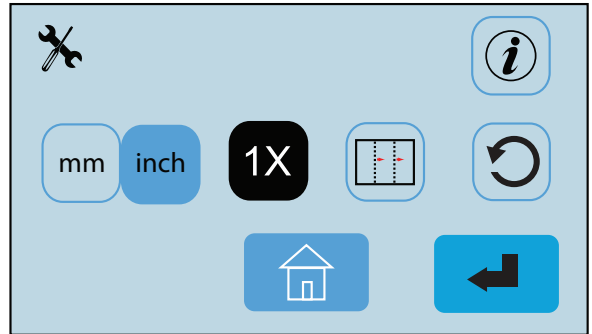



Fig. 36

Operator Settings Screen

## Standard / Metric Settings

1. From the Operator Settings screen (Fig. 36) press the measurement setting icon  (Fig. 37) to change between settings. The icon highlights in blue is the selected setting. By changing this setting the paper sizes will change from standard to metric or vice versa.

Press the home icon  to return to the Home Screen.

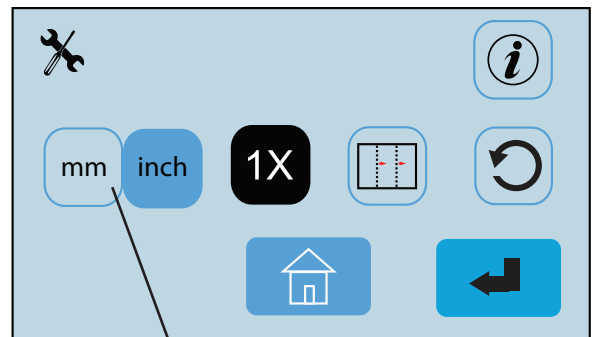



Fig. 37

Standard / Metric Icon

## Standard Fold Override

1. It may be necessary to adjust the factory set standard fold settings for a particular fold type and paper size. This can be done in the Standard Fold Override Mode. From the Operator Settings menu select the Standard Fold Override icon  (Fig. 38) and press the enter  icon to select.

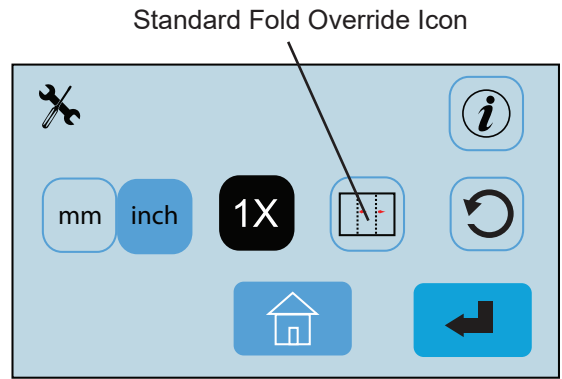

Fig. 38

2. “Standard folds will be modified from factory settings” warning will be displayed (Fig. 39). Press the green box with the check to continue or the red box with the X to exit and return to the operator screen.

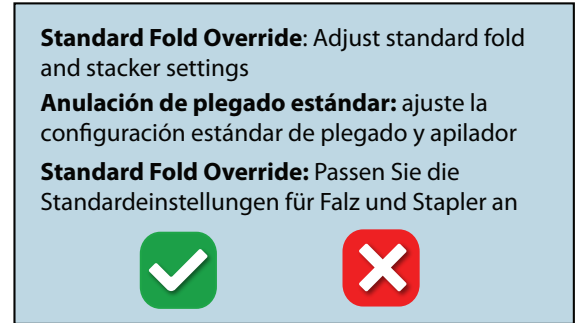



Fig. 39

3. From the Standard Fold Override Screen select the paper size and fold type that you would like to override (Fig. 40). Then press the enter  icon.

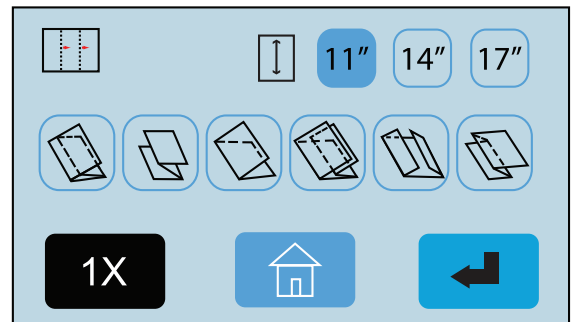



Fig. 40

4. Follow the same procedures as the custom fold settings to adjust the folds (Fig. 41). Press the Test icon  to confirm the change is correct. If the settings are good press the Save Icon  to save the new settings. A save confirmation will be displayed.

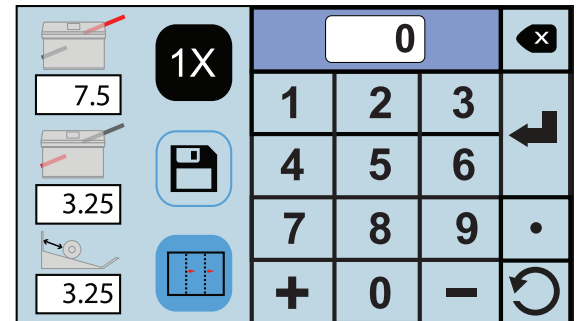

Fig. 41

Press the green box with the check to continue or the red box with the X to return to the fold setup screen (Fig. 42).

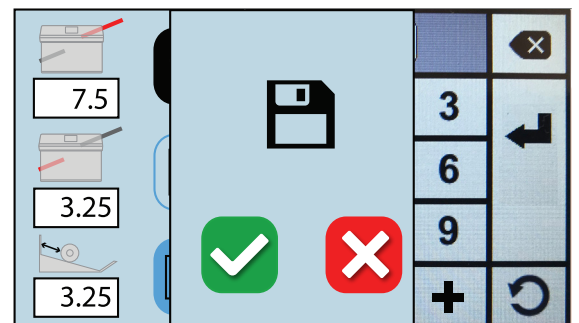



Fig. 42

## Test Sheet Setting

The number of test sheets can be changed between 1, 2 or 3.

1. From the Operator Settings Menu press the Test Icon  to access Test Sheet Setting (Fig. 43).

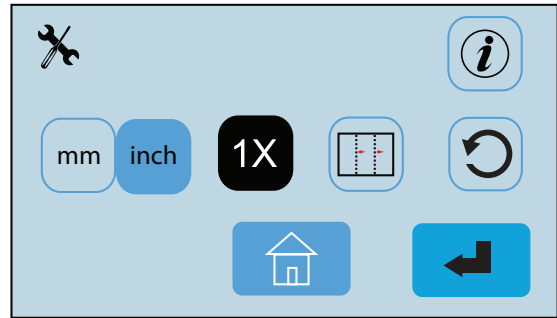



Fig. 43

2. The number of test sheets can be changed to 1, 2, or 3. Press the corresponding test button and then press the enter icon  to save the selection. The chosen icon will be highlighted in black (Fig. 44).

Press the Home button  to return to the Operator Settings screen.

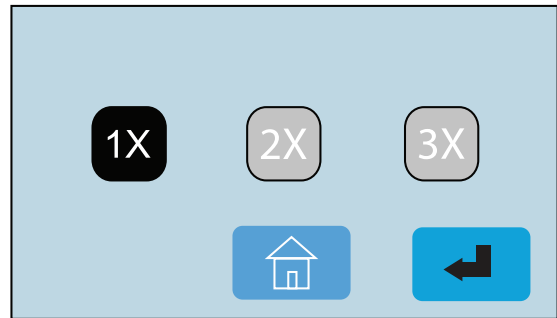



Fig. 44

## Default Settings - Return to Factory Settings

1. From the Operator Settings screen press the Default Settings icon  (Fig. 45). A confirmation screen will come up. Press the green box with the check to confirm or the red box with the X to cancel the setting (Fig. 46).

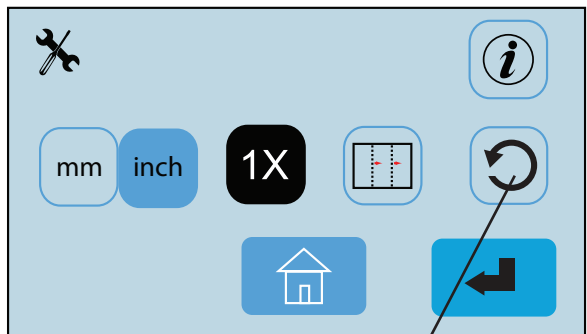

Fig. 45

Default setting Icon



Fig. 46

Default setting confirmation screen

## MULTI-SHEET FEEDING

The multi-sheet feeder is designed to fold pre-collated stapled or unstapled sets of up to four 20 # (75gsm) sheets of paper. You may need to create a custom fold, depending on the thickness of the finished multi-sheet set.

1. Select the fold type and paper size (see page 6). The Multi-Sheet Feeder accommodates 11" and 14" paper lengths.

Adjust the side guides on the multi-sheet feeder for the proper paper size. Loosen the brass thumb screw, adjust the guides to fit the paper width and re-tighten the thumbscrew (Fig 47a).

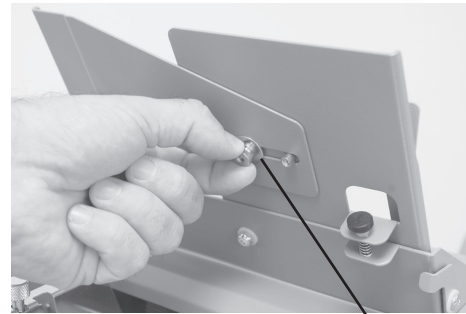

Fig. 47a

Brass thumbscrew

2. Slide the pre-collated paper set into the multi-sheet feeder. When feeding stapled sets the documents should be placed with the staple on the operator's side and leading (Fig 47b).

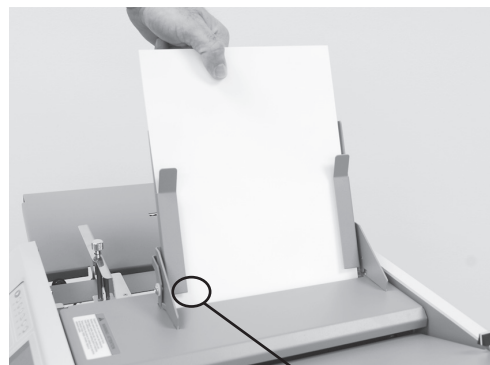

Fig. 47b

Staple

3. The sheets of paper will be automatically pulled into the folder (there is a one-second delay after the paper is placed in the feeder).

4. If the fold is skewed, turn the skew adjustment knob located on the back of the feeder left or right to make corrections (Fig 47c).



Fig 47c

Skew Adjuster

5. To remove the multi-sheet feeder, depress the release levers located on either side of the lower back side of the feeder (Fig. 47d), tilt the feeder forward and lift. To reinstall depress the levers and reinsert.

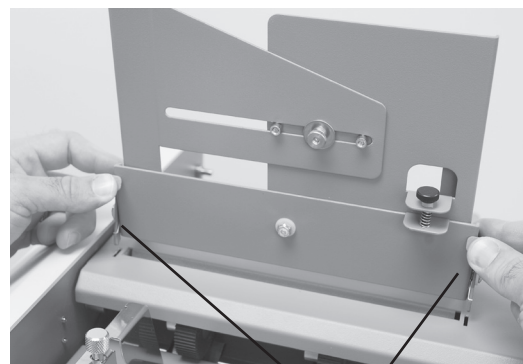

Fig. 47d

Release Levers

# CROSS FOLDING

Cross folding refers to folding a document in one pass and then running it through the folder a second time to be folded again.

Common Application: Folding a 11" x 17" document in half and then letter folding it to fit in a standard #10 envelope.

1. Load folded paper into the feed tray with the fold crease facing the non-operator side of the folder (Fig. 48a).

**Note:** For best results, firmly run your hand over the fold crease to help flatten the paper before loading.

2. Attach the cross fold paper guide onto the feed tray paper guide (Fig. 48b) and lower guide.

**Note:** Cross folding ability will vary based on the paper weight and type. If the paper is too heavy it may not be able to be cross folded.

**Note:** The guide can be conveniently stored under the lower fold table when not in use (Fig. 48c).

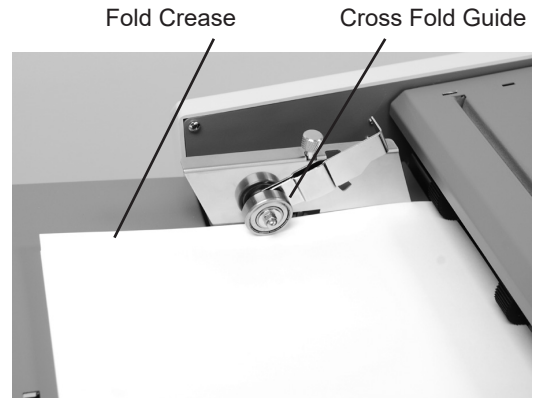

Fig. 48a

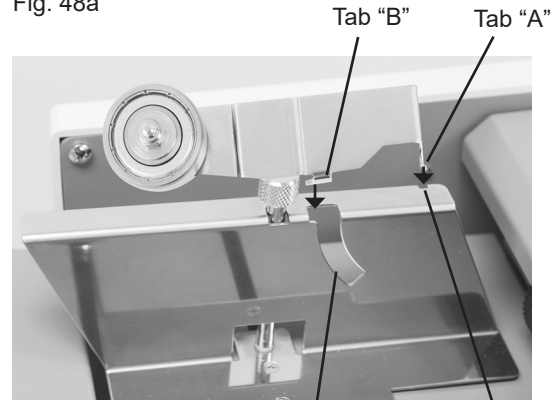

Fig. 48b

*To install cross fold guide hook tab "A" into slot "A" and then lower tab "B" into slot "B"*



Fig. 48c

Cross fold guide storage



## REMOVING OUTFEED COVER

The outfeed cover can be removed to access the exit roller. To remove, unscrew thumbscrews that hold the cover in place (Fig. 15)

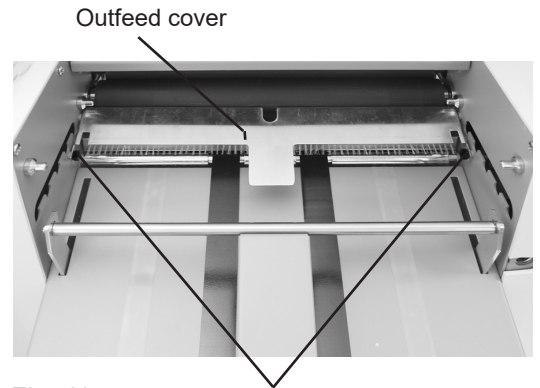

Fig. 49

Thumbscrews

## REMOVING INFEED TIRES

The infeed tires can easily be removed for cleaning and replacement. Remove the Allen screw located on the left side of the feed tire shaft (Fig. 16). Slide the shaft to the right to release from the side frame and remove (Fig. 17).

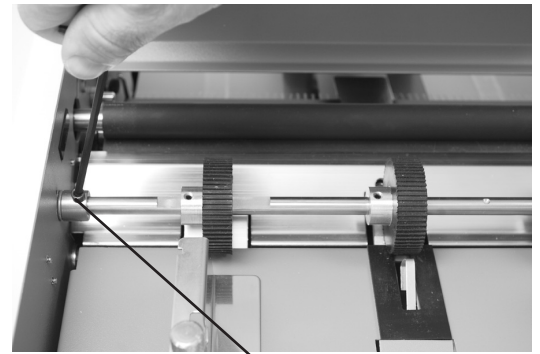

Fig. 50

Allen Screw

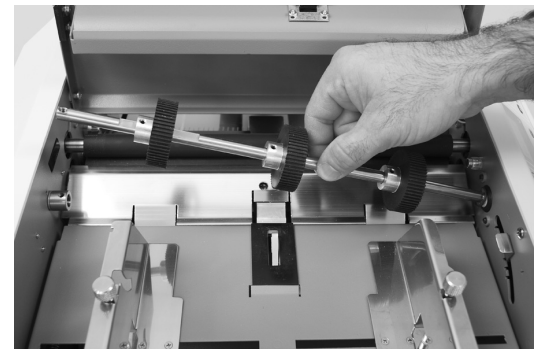

Fig. 51

# OPERATOR MAINTENANCE

1. It is recommended to let forms cool for one-half hour, from the laser printer, before folding. This allows toner to set on the forms and static electricity to discharge. The FD 402 Jogger is recommended for best results. The Jogger squares the forms and dissipates heat and static electricity created by laser printers.
2. Clean infeed tires and fold rollers with Formax recommended roller cleaner & rejuvenator to remove paper dust and toner. A Formax Cleaner Kit is available from your dealer. A damp cloth with water is the best alternative.

**CAUTION:** Do not use any chemicals other than the roller cleaner & rejuvenator or water.

## CLEANING PROCEDURES:

1. Make sure machine is turned off and unplugged. All folders have four (4) rubber rollers (Fig. 18).
2. Remove the upper and lower fold tables.
3. Using Formax roller cleaner, spray a new cotton cloth until the cloth is saturated. Wipe the wet cloth in a back and forth motion making sure to clean the entire surface of the fold and rollers. Next use a dry cloth and wipe off excess toner. The cloth should be covered with black toner surplus from cleaning the rollers.
4. Run 10-15 sheets of blank copy paper through the folder to ensure all cleaner has been removed from the fold rollers. Running blank sheets will remove any excess residue of cleaner on the rollers.

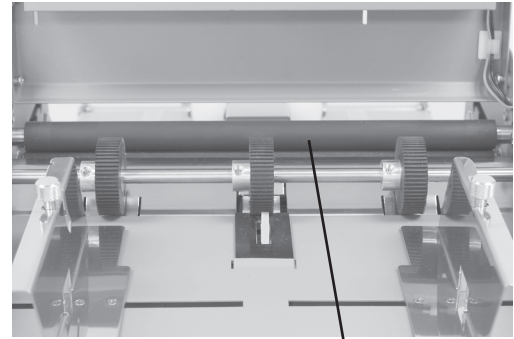



Fig. 52

Fold Rollers

# ERROR SCREENS

## Paper Misfeed / Paper Jam



A misfeed has occurred. Reset the stack of paper in the infeed and press the  icon to resume operation. A Paper jam has occurred in one of the areas indicated. Turn the folder to the off position and unplug. Check the area indicated for paper and remove. Replace the fold plates and plug the folder in and the power on.

## Paper Out

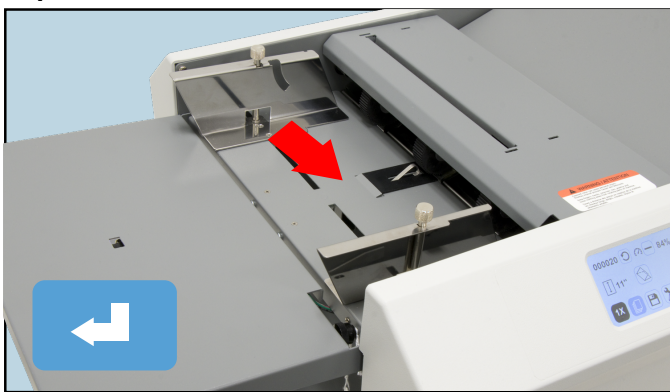

There is no paper in the infeed. Reload paper and press the  icon to resume operation.

## Cover Open

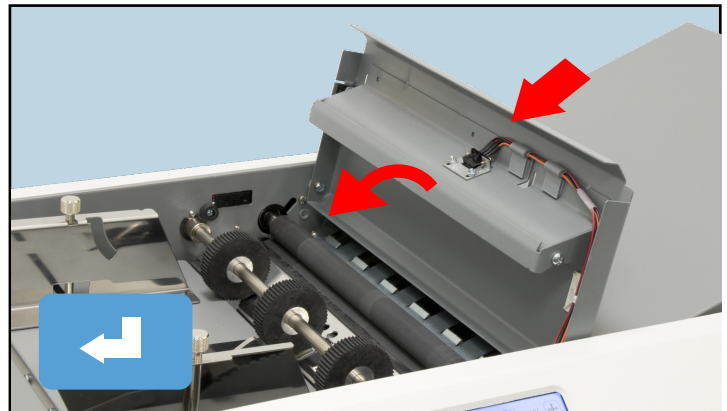

The top cover is open. Close the top cover and press the  icon to resume operation.

## TROUBLE-SHOOTING

TROUBLE	POSSIBLE CAUSE	REMEDY
Control panel is not illuminated.	Power switch turned off. No power at the wall outlet. No power to the machine inlet. No power to the control panel. Internal electrical failure	Turn on power switch. Check wall outlet. Check power cord for frayed/broken wires. Press the button on the circuit breaker. Call for service.
Fold table stop not moving when “Test”/ “Start” is pressed.	Fold table is not plugged in. Electrical or mechanical failure	Plug in fold table. Call for service.
“Cover Open” image is displayed.	Cover open Magnetic switch is broken.	Close cover. Call for service.
“Paper out” image is displayed.	Infeed tray is empty.	Place documents on the infeed tray.
“Paper Jam / Misfeed” image is displayed.	Paper misfeed Paper jammed at exit of folder	Reload paper and press “Counter Reset” button. Remove paper and press “Counter Reset” button.
Black marks on the folded paper.	Infeed tires, separator, and/or fold rollers are dirty.	Clean the parts with approved roller cleaner and rejuvenator.
Fold is skewed.	Infeed tray is out of adjustment.	Turn skew adjuster knob to remove the skew.
Stacker belts do not turn.	Broken drive belt, worn drive gear.	Call for service.
Documents are wrinkled or crunched.	Fold tables are not inserted correctly. Piece of paper or other material is stuck in the fold table.	Remove and reinstall fold tables. Be sure they’re properly positioned. Remove object from the fold table.
Infeed tray lever does not work	Broken spring	Call for service.
Double feeding forms	Documents stuck together More tension is needed Feed tire or separator worn	Jog forms to remove static electricity. Adjust the infeed tension lever (page 5, Fig. 8) Call for service
Not feeding documents	Feed tires are dirty Feed tires or separator worn	Clean feed tires Call for Service
Power loss	Circuit Breaker tripped Under adverse conditions, power input level may drop below acceptable limits	Press black reset button next to power inlet. When power is restored, turn off machine, then turn on again to restore normal operations.

