

FORMAX[®]

7104 Series
High-Volume Modular Inserter

Table of Contents

1	Read this First	1
	Safety.....	1
	Declaration of Conformity (EU only).....	1
	About this manual.....	1
2	Introduction	3
	Introduction.....	3
3	Description of machine	4
	Description of operation.....	4
	Identification of parts.....	5
	Switching on the machine.....	8
4	Control Panel	10
	The Job Screen.....	10
	The Run Screen.....	12
	The Menu Screen.....	24
5	Running an existing job	25
	Running an existing job.....	25
6	Switching the user	28
	How to switch the user.....	28
	User Access Rights.....	30
7	Creating a job	32
	Creating a job.....	32
	Creating the Job Settings.....	33
	Creating an envelope.....	55
	Creating a document.....	58
	Creating an enclosure.....	63
8	Loading the paper hoppers	65

	Loading the envelope hopper.....	65
	Loading the feeder hopper.....	68
	Loading the tower folder hoppers.....	71
	Daily Mail Tower Folder.....	74
	Adjusting the catch tray.....	76
9	Operator Maintenance	77
	General Cleaning.....	77
	Cleaning the sensors.....	77
	Clearing paper jams.....	86
	Maintaining the Wetter System.....	89
10	Technical Specification	90
	Inserter head.....	90
	Tower Folder.....	93
	Insert Feeder (Single, Twin & Reading).....	95
	Feeder Folder.....	96
	Mechanical & Electrical.....	97
11	Glossary of terms	100
	Glossary of terms.....	100
12	INF Output Conveyor - appendix	107
	Introduction.....	107
	Description of machine.....	107
	Setting up the machine.....	110
	Using the machine in IMOS.....	111
	Operator Maintenance.....	119
	Technical Specification.....	121
	Troubleshooting Guide.....	121

1 Read this First

Safety



Ensure you have read and fully understood the safety requirements in the Safety Guide.

Declaration of Conformity (EU only)

The product presented in this guide meets the requirements of applicable directives. For more details refer to the Declaration of Conformity. Contact your authorized distributor for availability of this document.

About this manual

Disclaimer

This Guide is published without any warranty. Improvements and changes to the online Guide necessitated by typographical errors, inaccuracies of current information, or improvements to programs and/or equipment, may be made at any time and without notice. Such changes will, however, be incorporated into new editions of the PDF Guide (if applicable).

Symbols

This manual uses the symbols listed below.



WARNING : Indicates a human safety hazard.



ATTENTION : A risk to the equipment or mail could result from an action you may perform.



NOTE : A remark that explains different cases or specificities.



TIP : Advice to help save you time when processing your mail.



SUPERVISOR : Indicates that you have to use the supervisor menu to perform the procedure.

Languages

In the EU the user guide must be available in the national language(s) of the country where the system is delivered. Therefore, if the User Guide is not available in your country's language(s), contact your authorized distributor.

Introduction

Introduction

With this inserter you have an advanced, medium-volume folding and inserting machine. Its modular construction allows multiple feed units to be fitted, with a maximum of 17 feed units. Its sophisticated software control optimises the order and flow of documents for collating at the insert head before insertion into the envelope. All fold and adjustments take place automatically according to the requirements programmed in by the operator.

In order to ensure the long usage of this machine and its components, and above all the safe use of the machine, you must read and adhere to the operating instructions and safety notes. Always be aware of all warnings and notes that are mounted or noted on the machine itself.

All persons entrusted with the handling of this machine must also be familiar with the operating manual.

Save this handbook carefully, so that the information it contains may be available at all times.

Notes on the use of this handbook

This document contains all general information and explanatory text necessary in order to be able to carry out the operation of the machine.

When some action is expected from the operator, this will always be explicitly stated, and where relevant, accompanied by an illustration or graphic.

Always read through each step, so that you will obtain all of the necessary information. Do not anticipate what you believe will follow in the handbook: It will prevent you from making mistakes!

Chronology and Reference

This handbook is structured chronologically, and therefore ordered sequentially for the operationally ready machine. It assumes that the machine has been installed in the correct environment by an Authorised Service Engineer and that the operator or his or her supervisor has had a degree of operator training.

When you are unfamiliar with the machine, it is best to read through the handbook from beginning to end. You will be guided step by step, and in this way you can easily and quickly have the machine in operation.

If you are already familiar with the machine, it will make things easy if you use this handbook as a reference work.

3 Description of machine

Description of operation

The function of the machine is to fold forms to 'C', 'Z', 'V' or double forward fold, either singly, in fixed multiples or in varying groups. Enclosures such as inserts, BR envelopes etc. may be added. Folded forms and enclosures are collated in the collation area in the inserter head before insertion into the envelope. Forms may be inserted without sealing the envelope for subsequent checking or hand insertion.

There is a batch processing facility, allowing a preset number of cycles to be completed before the machine automatically stops.

The machine is OMR/Barcode/2D compatible for use with a reading feeder or tower folder, allowing a group of forms to be collated on the track prior to folding. A number of barcode symbologies may be read.

The machine consists of a number of modules, depending upon the build ordered - these modules are briefly described below:

- **Inserter head** - Collates all documents in a pocket before insertion, feeds the envelope, inserts the pack and seals the flap.
- **Feeder** - Feeds shortform inserts (cards, BR envelopes, booklets etc.) onto the track for subsequent insertion. Available with single or twin feed hoppers. An OMR/Barcode/2D version is also available.
- **Feeder Folder** - Track mounted folder for folding document inserts. Fitted with a 2-plate folder mechanism for C, Z or V folds. Single hopper only.
- **Tower Folder** - Mounts at the end of the machine. Folds documents either separately or in groups, using an accumulator if required. Fitted with either a 1 x 1000, 3 x 500 or 1 x 1000 plus 1 x 500 sheet trays. Uses a 3-plate folding mechanism. An OMR/Barcode version is also available (top or bottom read).

The machine is equipped with PC controlled operating software from where jobs can be programmed and run. The number of jobs that can be programmed is limited only by the capacity of the PC. Input is via touchscreen monitor or keyboard/mouse.

A daily mail function can be used as an optional feature on a Tower Folder. This allows groups of documents, stapled or loose, to be hand-fed; they will then be folded and inserted into an envelope (flex folder only). If other hoppers are loaded, further forms can be collated.

No manual setting of the fold plates or envelope closer is required, these being adjusted automatically according to the settings in the selected program.

An optional output conveyor can be specified, to replace the standard receiving tray. This can be fitted in two possible orientations.

Identification of parts

The main parts of the machine are shown below.

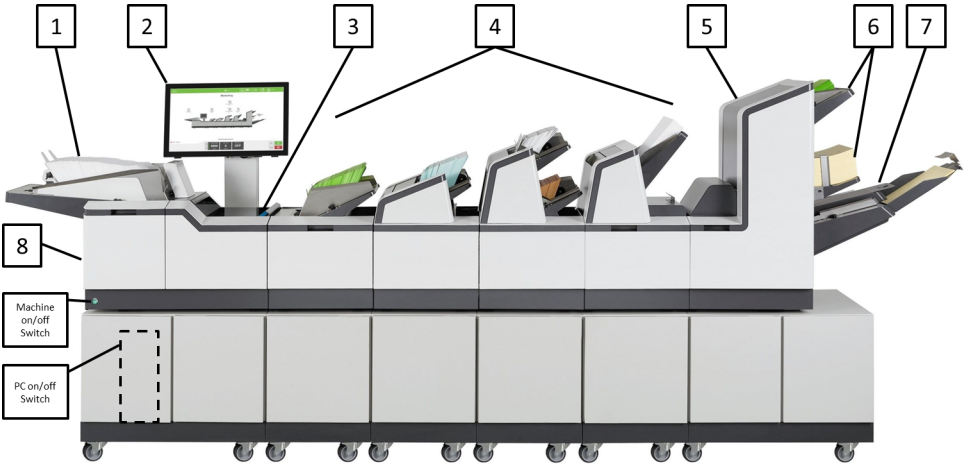

- 1. Envelope feeder**
Holds up to 800 DL envelopes. Fitted with a sensing conveyor that operates on demand to move the envelope stack forward.
- 2. Touch-sensitive monitor**
Runs the IMOS operating software and responds to button pushes. A keyboard and mouse are also fitted.
- 3. Collation and insertion area**
Folded forms, either singly or in groups, are collated here into one pack, along with enclosures. The pack is then inserted into the envelope.
- 4. Feeders/Folders**
These are track mounted units, with an end-station variant also available. Up to 17 feed trays may be fitted.
The feeder (single or twin) feeds enclosures such as inserts, flyers, BREs etc. The hopper holds up to 300 BREs. A reading variant for OMR/ BCR/2D is also available, as is a feeder folder for long documents, with hopper capacity of up to 500 sheets of A4 80gsm.
- 5. Tower Folder**
This is a folder unit and is only available as an end module. It can be fitted to the insertion head on its own, or in conjunction with feeders. It is fitted with various options of feed pods and an accumulator (see following page).
- 6. Feed Trays**
Fitted to the Tower Folder. 3 options available: 3 x 500-Tray, 1 x 500 with 1 x 1000-Trays & 1 x 1000-Tray; all variants can be mark reading as an option.
- 7. Accumulator**
Fitted to the Tower Folder and allows groups of forms to be collated together before folding as a group. It is an optional item, it is also fitted with a diverter tray (supplied by default if on reading versions).
- 8. Closer/Eject Area**
This is where the envelope flap is closed and sealed before ejected the filled envelope into a receiving tray or onto a conveyor.



Items 1, 2, 3 & 8 are all part of the Insertion Head Unit.

Switching on the machine

The machine and PC must be switched on separately.
Press the green button at the front of the inserter.



3

English

Open the cupboard below the Inserter and press the On/Off button on the PC.



3

English

4 Control Panel

The Job Screen

This is the screen displayed when the machine starts up.

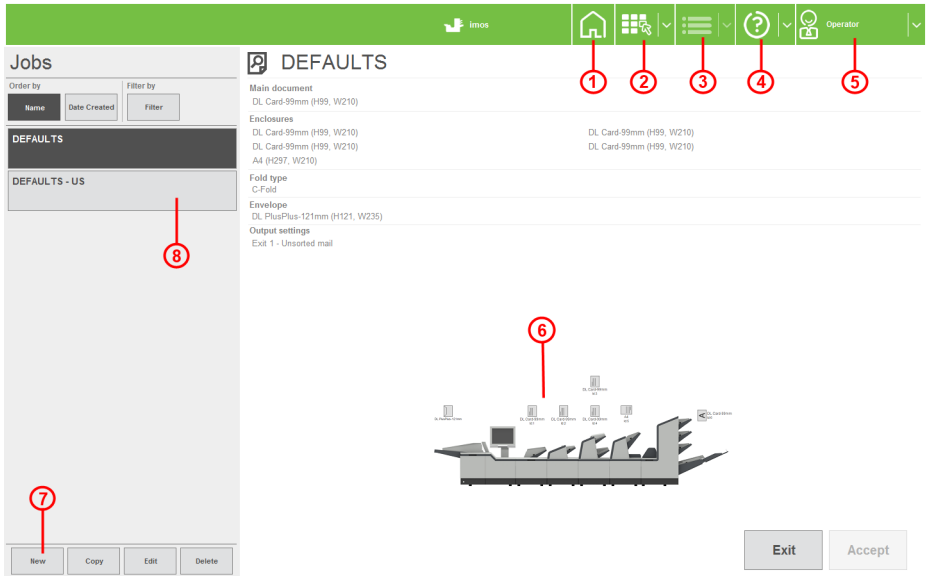

1. Run screen
2. Job screen
3. Menus (pull down)
4. Online help
5. Users menu
6. Graphic shows machine configuration
7. New job button
8. List of existing/available jobs

4

English

Press **'Online Help'** to access this document. Press **'Remote Assistant'** to access assistance via Team Viewer - see [Remote Assistant](#) on page 23 for further details.

Menus (including Engineer & Admin screens) are only available if logged in as Supervisor or Engineer.



See [Running an Existing Job](#) on page 25 for running an existing job directly from this screen.

The Run Screen

The Run Screen displayed

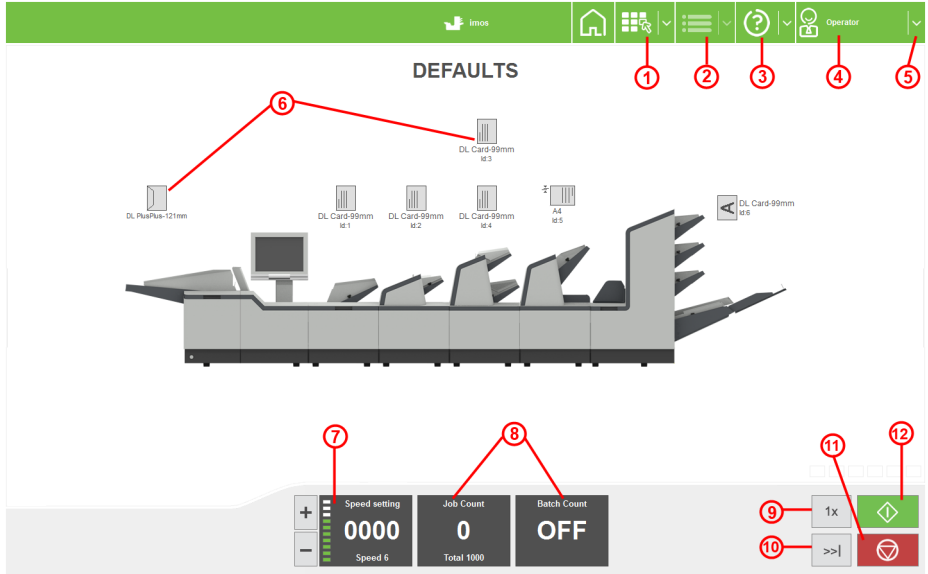

This is the screen you will see after an existing job has been selected in the Job Menu.

1. Job screen
2. Menu screen
3. Online help
4. Users menu
5. Shut down IMOS *
6. Paper load indicators
7. Speed controls & indicator
8. Counter settings
9. Single cycle
10. Autoend
11. Pause
12. Run

* This button closes down the IMOS operating software - it does **not** switch the machine off.

To change the current user or job, click on the buttons and you will be presented with a list of all those that have been created, and allow you to select any one. Note that to change to a different user will require the appropriate password to be entered. To view and adjust the settings for the envelope and document inserters, click on the relevant part of the machine graphic (see the following pages for details).

Important: you must be logged in as Supervisor to change the current user or job.

Testing the mailset

This allows various adjustments to be made before beginning the job, in order to minimise insertion crashes.

1. Press the Single Cycle button  to open the following options:

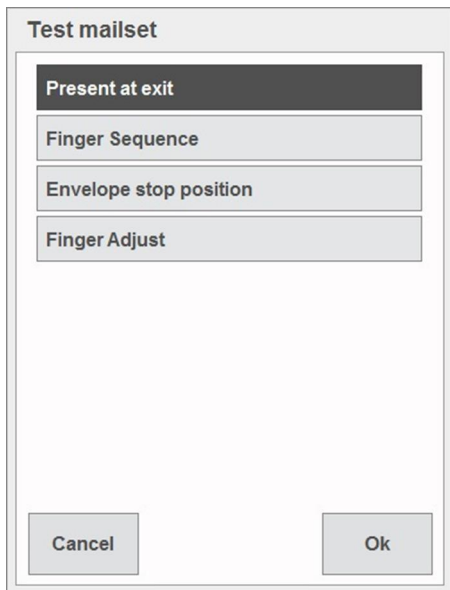

See following page for explanation of each button.

Present at exit

After pressing **Present at exit**, the first piece will be processed and the machine will stop to allow you to adjust the vertical alignment of the address, if required.

1. Remove the filled envelope and adjust as necessary, as shown below:



Finger sequence

Sets the order of insertion of the fingers in the envelope, whether inner or outer fingers first, or both together.

1. Press **Finger Sequence** – the machine will feed an envelope into position and present the following screen:

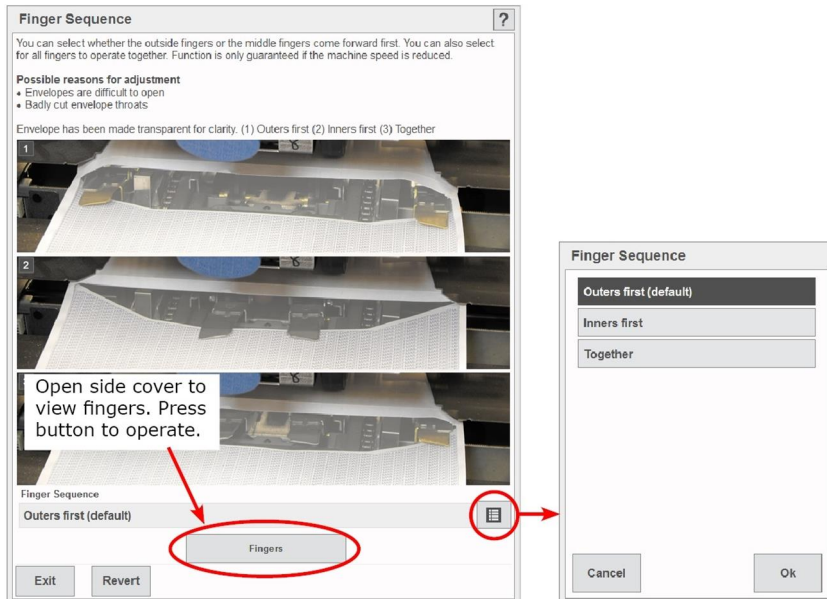

2. Select required sequence. Press **Revert** to restore machine default.

Envelope Stop Position

Allows the stop position of the envelope at insert to be adjusted.

1. Press **Envelope Stop Position** – the machine will feed an envelope into position and present the following screen:

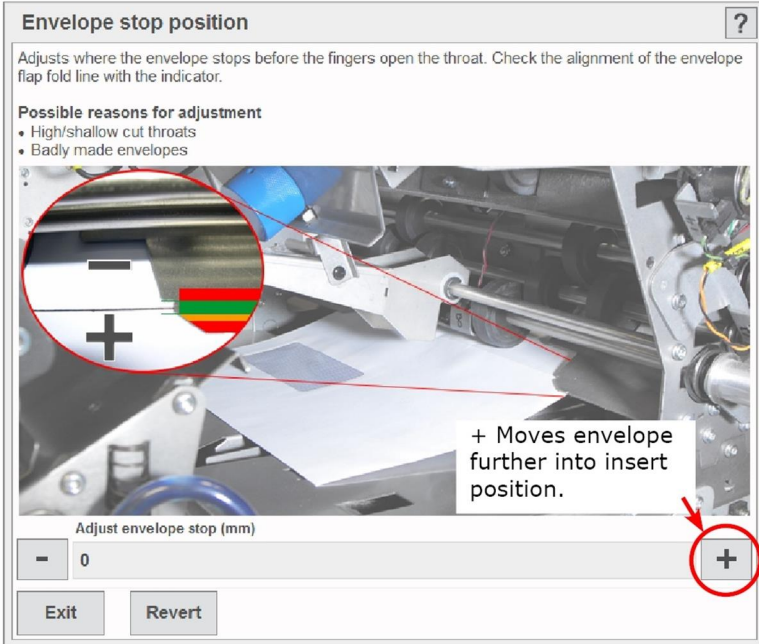

2. Adjust as required. Press **Revert** to restore machine default.

Finger Adjust

Allows the width of the outer fingers to be adjusted.

1. Press **Finger Adjust** – the machine will feed an envelope into position and present the following screen:

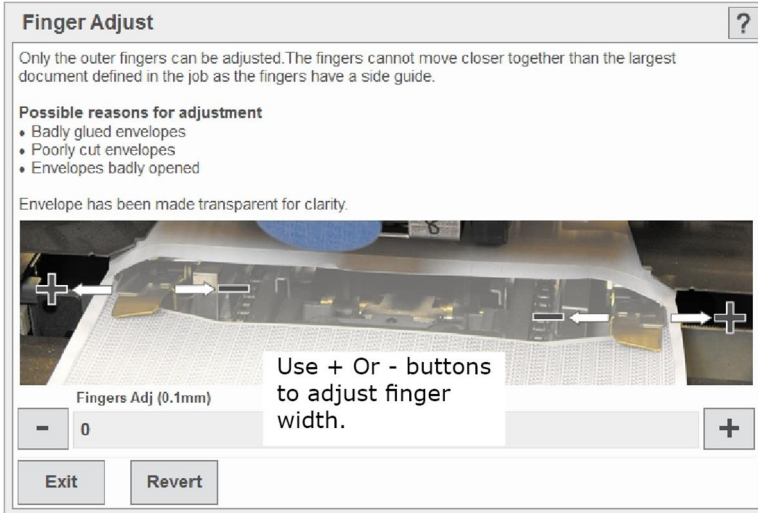

Counter settings

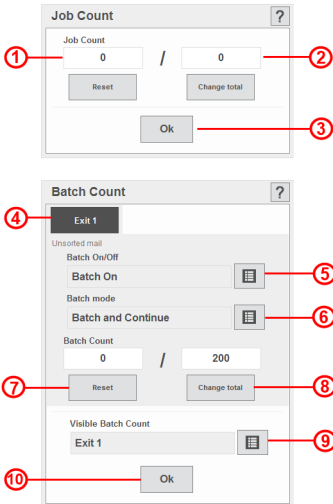

Press the **Edit** button next to the counters to display the Job Count and Batch Count box:

1. Applies to current job until it is changed, even if machine is switched off and later resumed. Press **Reset** to return to zero.
2. Press **Change total** to set the total for the job. When total is reached, machine will continue anyway.
3. Press **OK** to confirm the change.
4. Select the exit that you want batching to apply to (if required). **Note:** Exits 2 & 3 will only appear if one or more Sorters are fitted.
5. Switch batch on if using this function.
6. Set batch mode as follows for when batch quantity is reached:
 - **Batch and Continue:** Machine will pause for the specified pause time and then resume.
 - Note:** conveyor will continue to run during the pause time.
 - **Batch and Stop:** Machine will stop and resume only when the Run button is pressed.
7. Press **Reset** at any time to return to zero.
8. Press **Change total** to set the batch quantity required. **Note:** This total applies to the Exit selected above.
9. Select the Exit that you want the Batch Count displayed on the Run Screen to apply to.
10. Press **OK** when all settings are complete.

Adjusting the Envelope Inserter settings



The Sorter can be optionally fitted with a catch tray at either exit. This receives the envelopes in a stack to allow subsequent hand removal. It is adjustable to suit a variety of envelope sizes.

Unit Fine Tuning

1. Select the inserter icon on the machine graphic in the Run screen to display the fine tuning screen.

2. Select **Hardware Fine Tuning** to display further information.

Hardware Fine Tuning: Module 0: Head			
COLLATING			
Collate Pkt. Adj (0-1mm)	0	-	+
ENVELOPE INSERTION			
Fingers Adj (0-1mm)	0	-	+
Adjust envelope stop (mm)	0	-	+
Finger Sequence	Outers first (default)	Select	
WETTING AND SEALING			
Seal Time (ms)	40	-	+
Adjust wetter start (mm)	0	-	+
Adjust env seal pos (mm)	0	-	+
Adjust env reverse pos (mm)	0	-	+
MISCELLANEOUS			
Linear Speed	Auto	Select	
Env Conveyor Drive Delay	0 (default)	Select	

You can change:

- **Collate Pkt. Adj:** Width of collate pocket guides.
- **Adjust pawl pause pos:** Pause time after insertion. Increase if pawls start before previous pack has cleared.
- **Collate Slowdown:** Select 'Not on Last Form' for thick packs if final document in the pack does not feed fully into collate pocket.
- **Fingers Adj:** Overall width of insert fingers.
- **Adjust envelope stop (mm):** Stop position for insertion. + = towards exit.
- **Finger Sequence:** Change if envelopes not opening properly.
- **Insert in env position (mm):** Pack insertion into envelope. + = past flap crease.
- **Envelope Blower:** Increase opens envelope more. High for thick packs, low for single sheets/thin packs.
- **Seal Time:** Envelope ejects after.
- **Adjust wetter start:** When wetter beam drops. + = start point towards insertion area.
- **Adjust env seal pos:** Envelope into seal rollers. + = further in.
- **Adjust env reverse pos:** Envelope forward travel after wetting, before reversing into sealing rollers. + = into output rollers, towards exit.
Note: High-window envelopes, set to 20 - 50mm+.
- **Linear Speed:** Inserter head speed. Set lower speed if pack is not being fully inserted, eg. long packs.
- **Env Conveyor Drive Delay:** Number of envelopes on the conveyor before conveyor switches back on. Increase if envelopes 'bunching'.

Hopper Fine Tuning

1. From here you can adjust hopper settings. Select the envelope icon on the machine graphic in the Run screen to display further information.



You can change:

- **Seal Mode:** Eg. select 'Off' for later hand insertion of insert etc.

Adjusting the Document Unit settings



The fine tuning options available will depend upon whether a Feeder or Tower Folder is fitted. Note also that settings available will depend upon user access rights (see [User Access Rights](#)).



All fine adjustments apply only to the current job and will not affect any other jobs

4

English

Unit Fine Tuning

1. Select the document or insert icon on the machine graphic in the Run screen to display the unit fine tuning screen.

Fine Tuning: Module 0.Hopper 1		?	
Seal Mode	Always	Off	On
Deskew	Low	Select	
Wetter pump On		Wetter pump Off	
Exit		Advanced	

You can change:

- **Feed Control Mode:** If **Off**, unit is disused until turned back on.
- **Doubles Detect:** Turn **Off** if booklets/thick inserts used (Flex Folder only). If **On**, select Optical, Mechanical, or Auto.
- **Optical Doubles Sensitivity:** (Optical only). Low is more tolerant of high contrast printing.

Only for Reading units

- **Reset Seq. Count:** If Sequence OMR marks are in use and job is disrupted, select to reset the sequence.
- **Calibrate Reader:** follow the on-screen instructions to calibrate the CIS reader.
- **CIS Reader Diagnostics:** Displays the label of all documents in the group (up to 10), as seen by the CIS reader. Confirms that whole label was read, for example, or compare the images. Contact IPSS department for further diagnostic options.

The Menu Screen

4

The Menu screen allows various functions to be selected.

1. Libraries
2. Setup
3. Services

These functions are described in detail further in this document.

English

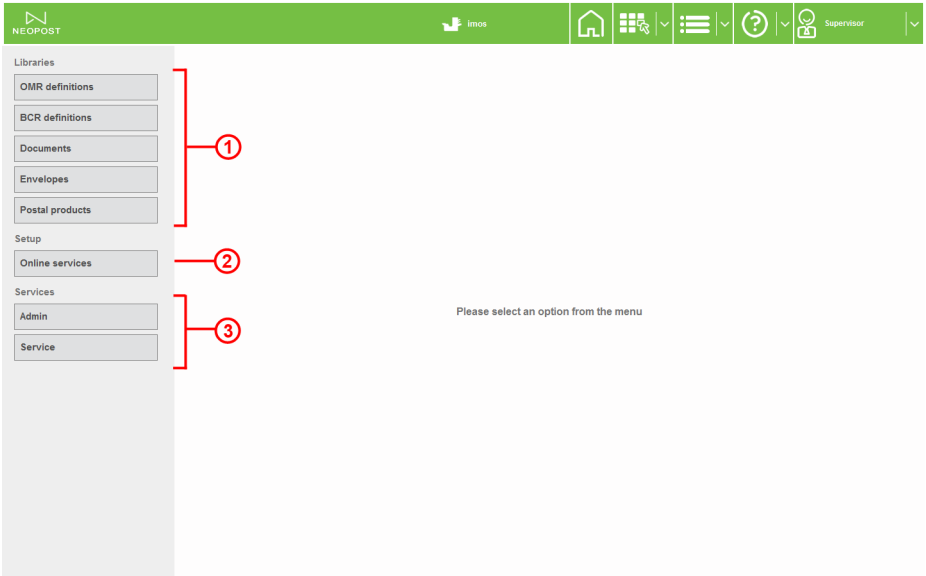

5 Running an existing job

Running an existing job



Paper is normally loaded in the Tower Folder face-up and feet-first if non-reading, but may be either way up if reading, depending upon whether top or bottom reading.



When using the cascade function, the Run button must be pressed while the machine is still running, after you have reloaded the empty hopper. This ensures the paper is fed to its pre-load position.

If this is not carried out the machine will stop, even though the hopper is full: if this happens, press the Run button to continue.

This section describes running an existing pre-programmed job. To create a new job, see [Creating a job](#) on page 32.

If the IMOS operating software is not already running, it must be started using the icon on the monitor screen. To access the PC to switch it on, open the cupboard door below the inserter head.

Before running a job, the paper hoppers must be loaded with documents - see [Loading the paper hoppers](#) for details.

1. If the Job screen is not already displayed, press the **Jobs** button at the top and select the required job from the list (in this case, **Mailshot Q3**). Use the scroll arrows if needed.

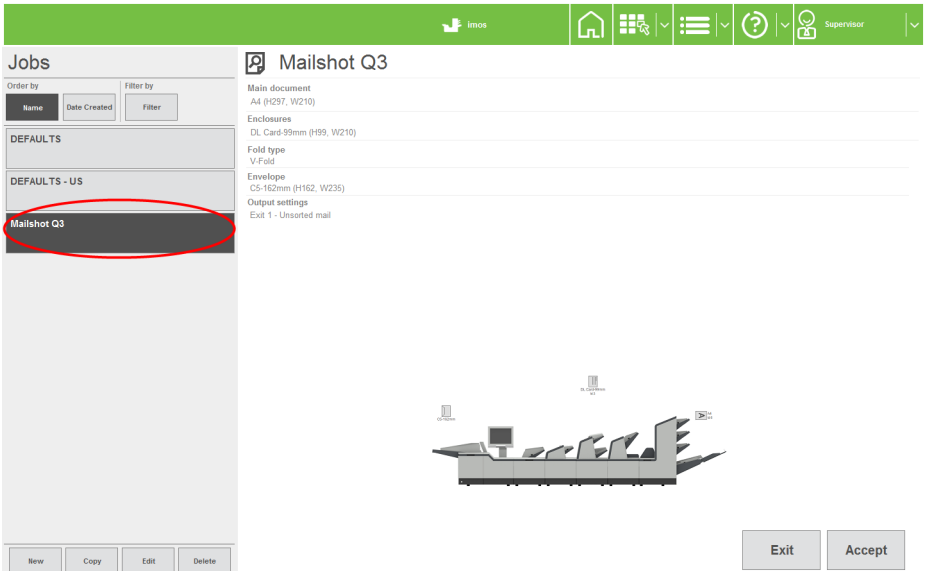

2. Summary of selected job is shown.

- If you are happy with your selection, press **Accept**, otherwise, select another job.

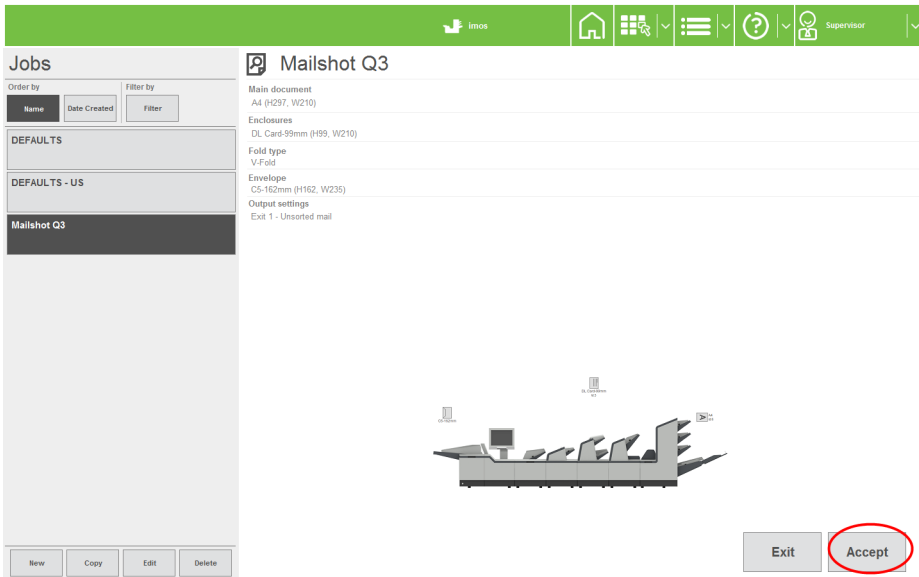

- Load the paper and envelopes in the hoppers indicated.

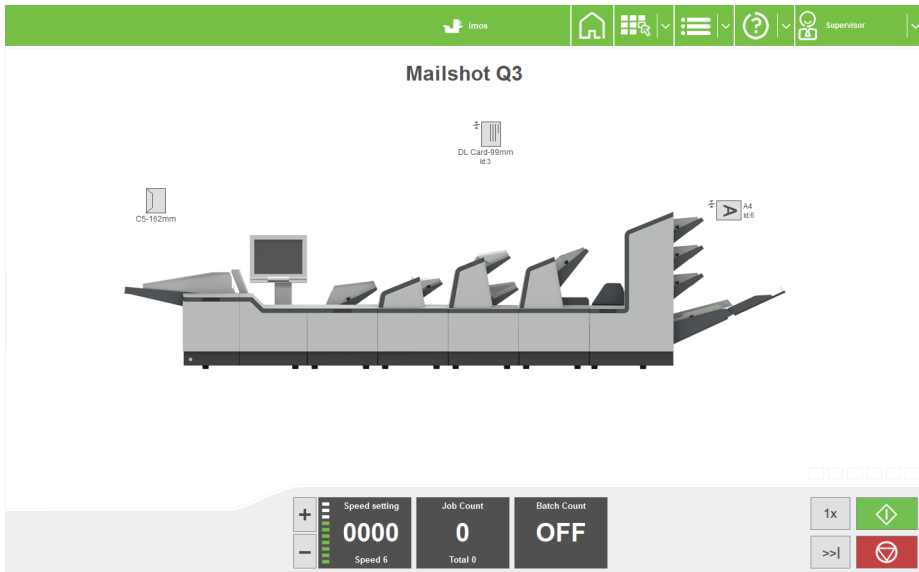

- Press the Run button to begin operating.
See also [The Run Screen](#) on page 12 for a full description of the controls.

6 Switching the user

How to switch the user

Each user has their own password and access rights, allocated by the Supervisor. To switch user, the password must be known.

1. Press the Switch User button in the Job screen

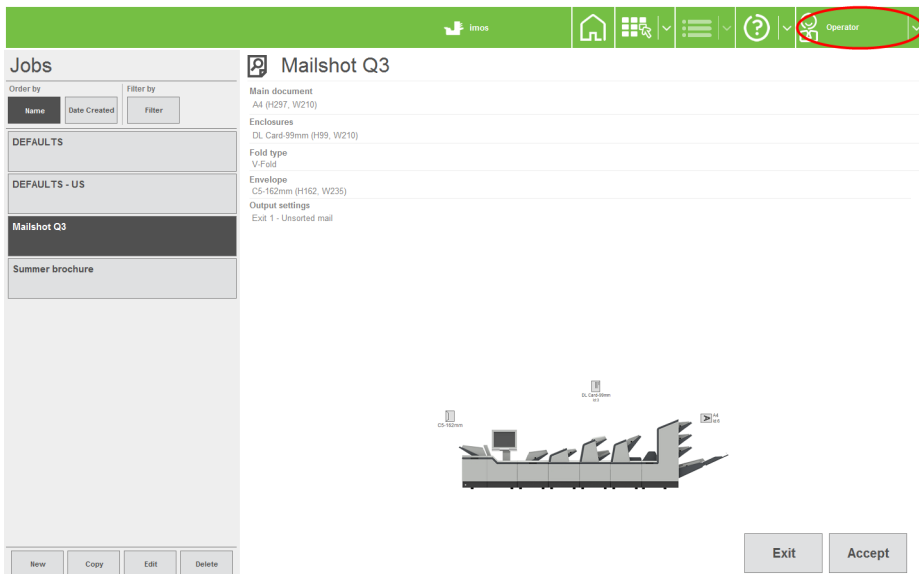

2. Select the user from the list. Use the scroll arrows if necessary.

3. Press the **Logon** button.

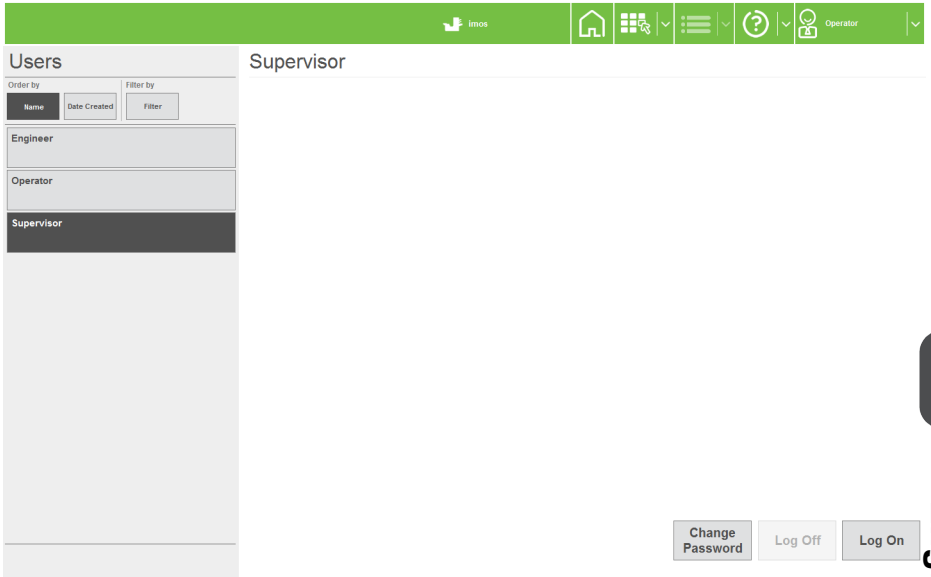

6

English

4. Enter the password using either the keyboard or the on-screen keypad. The user has now changed.

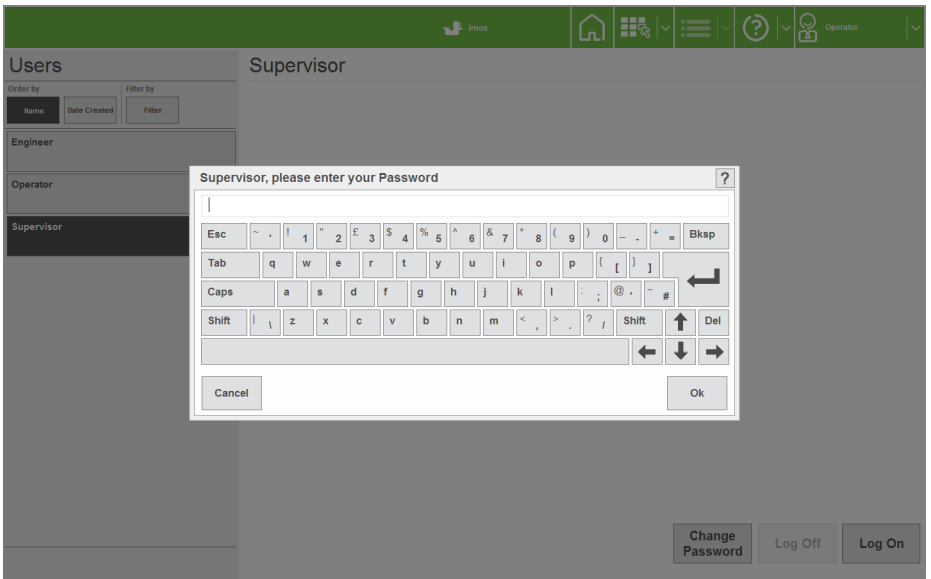

User Access Rights

There are 4 levels of access rights that can be allocated to each user. These are described below:

Rights	Operator	Expert Operator	Engineer	Supervisor
Change Jobs	Y	Y	Y	Y
Run Machine	Y	Y	Y	Y
Programme Jobs with Wizard	N	Y	Y	Y
Add items to Libraries from Wizard	N	Y	Y	Y
Add Items to Libraries from Outside Wizard	N	N	Y	Y
Mechanical Fine tuning	N	N	Y	Y
Document Fine tuning	N	Y	Y	Y
Enter Service Menu	N	N	Y	Y
Enter Admin Menu	N	N	Y	Y
PC Shutdown on Exit?	N	N	Y	Y

Additionally, the 'System Security Level' can be set by a Supervisor. This is the level where a user does not have to enter a password to perform certain operations. Any access rights needed above this level will require the user to logon with a password.

Level		Effective role of 'Operator'	Description	On Startup
Low (default)	Least secure	Expert Operator	Operator can run/edit/create jobs but cannot access the main menu.	Job screen displayed
Medium	More secure	Standard Operator	Operator can only run jobs.	Job screen displayed
High	Most secure	None	Operator has no access to the system. All users have to logon.	User screen displayed

7 Creating a job

Creating a job

Creating a job consists of a number of steps:

- Defining the Mailset (Envelope, document & enclosures)
- Defining the Fold Settings
- Setting required Output Options
- Saving the Job to a Jobname

When defining the Document in the Mailset, OMR or Barcode definitions can be enabled if required.



For an OMR or Barcode definition to be used it must first have been created - see [Creating a document](#) on page 58.

7

English

Creating the Job Settings

Creating the Job Settings

1. Press the **New** button in the Job screen.

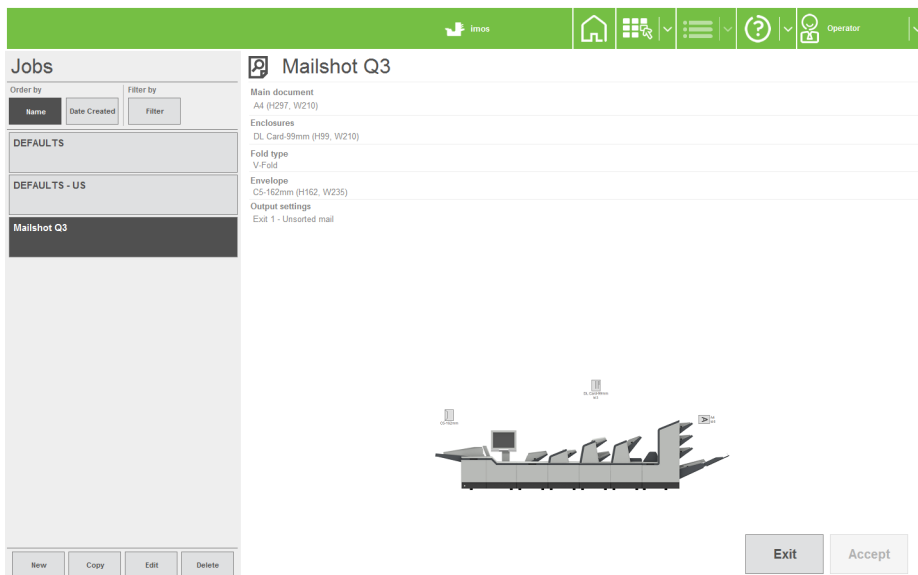

You will now need to define the mailset (envelope, documents and enclosures). This is described on the following page.

Defining the mailset

Selecting the envelope

1. Press the **Select** button to choose an envelope from the available library.

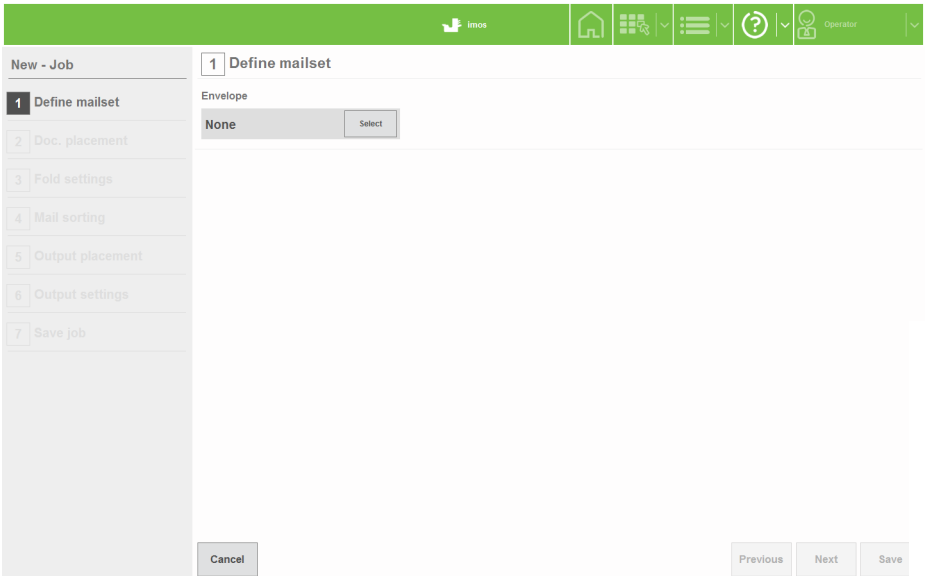

7

English

2. Select the required envelope from the library and press the **OK** button.

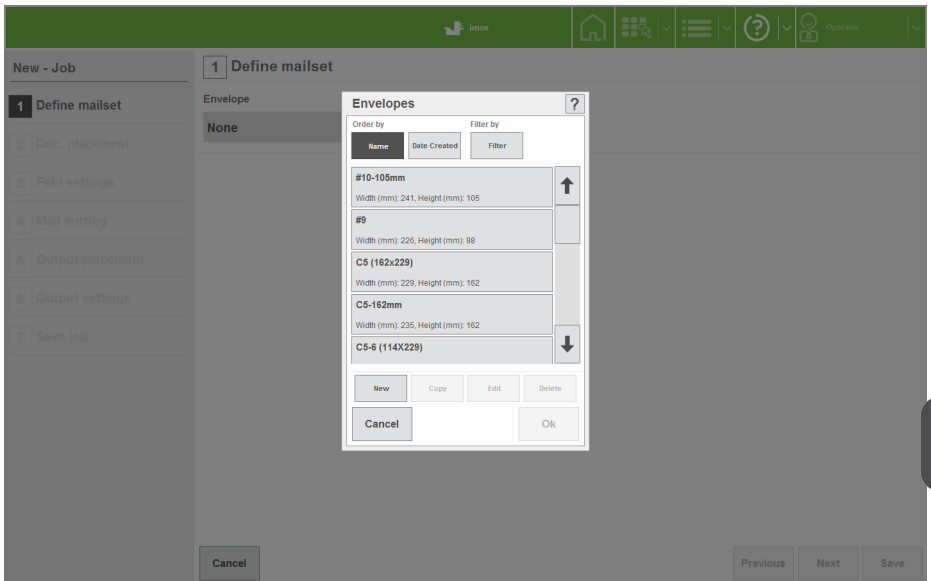

If there are no envelopes in the library, or if you wish to create a new one, see [Creating an envelope](#) on page 55.

3. You now have a choice: carry on to select a document, or further define the envelope usage, ie. sealing mode and the order of documents in an envelope. The following assumes you want to further define the envelope usage. When you have finished you will return to the screen shown here.

Press the **Settings** button.

The screenshot shows the 'Define mailset' screen in the Inos software. The interface has a green top bar with the 'Inos' logo and navigation icons. On the left, a sidebar lists steps: 1 Define mailset (selected), 2 Doc. placement, 3 Fold settings, 4 Mail sorting, 5 Output placement, 6 Output settings, and 7 Save job. The main area is titled '1 Define mailset' and contains two sections: 'Envelope' with 'C5-162mm' and a 'Select' button, and 'Main document' with 'None' and a 'Select' button. A 'Settings' button is circled in red in the 'Envelope' section. At the bottom, there are 'Cancel', 'Previous', 'Next', and 'Save' buttons.

7

English

4. Select the required Sealing mode (usually this will be 'Always'). Other options are:
- Off: sealing is disabled.
 - No-seal Label Select: reads no-seal character in label.
 - Off, flap open: envelope left unsealed with flap open.
 - No envelopes: envelope feeding disabled to allow forms only.

Press the **Edit advanced** button if you wish to change the 'Order of documents in envelope' setting.

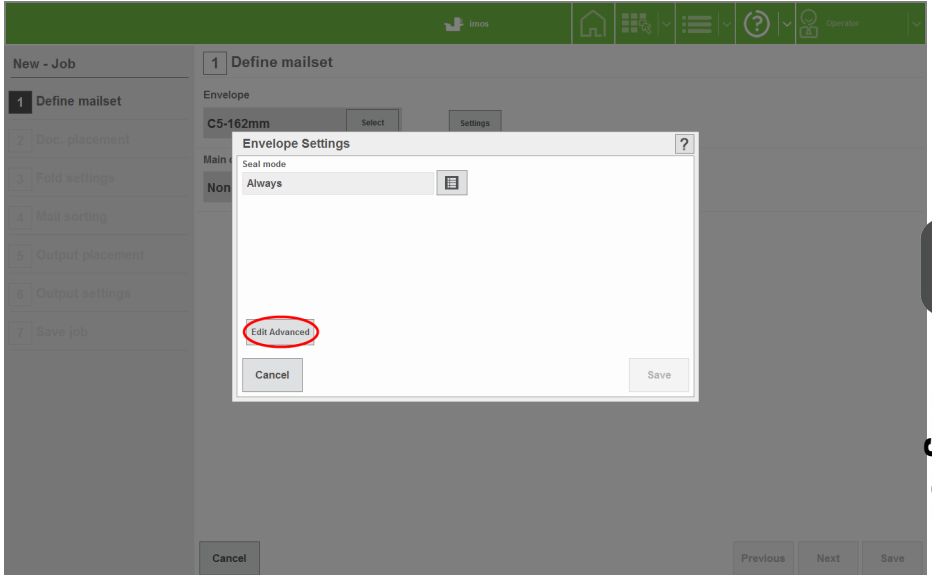

5. Change the order that enclosures are inserted into the envelope (default is **Automatic**). If set to **Manual**, enclosures are inserted in the order created in the job (see **Selecting the enclosure** at the end of this section).

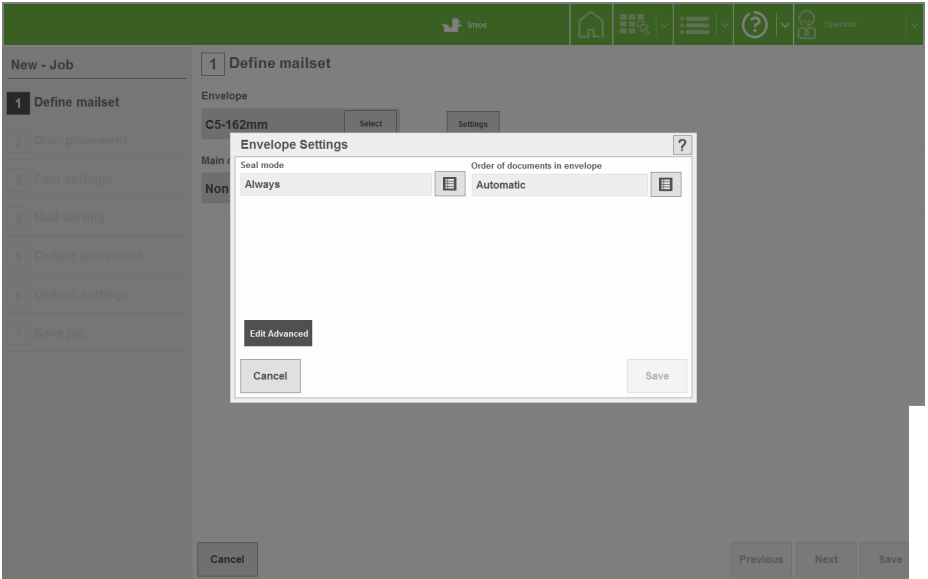

7

English

Selecting the document

1. Press the **Select** button to choose a document from the available library.

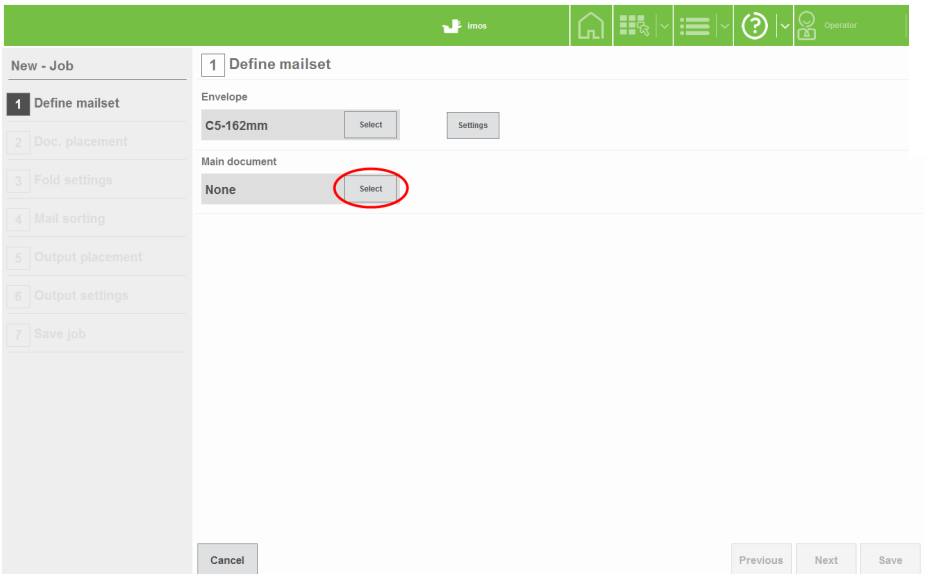

2. Select the required document from the library and press the **OK** button.

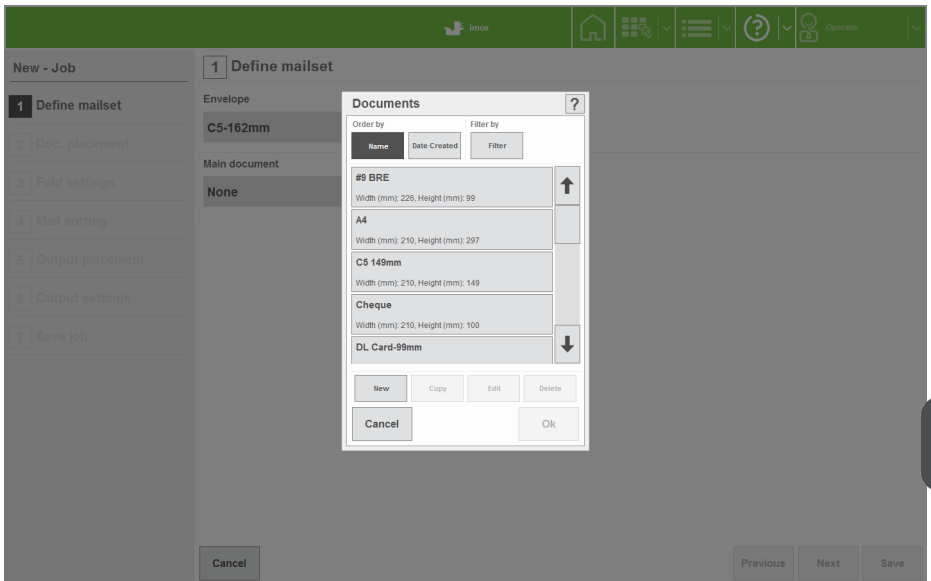

7

English



If there are no documents in the library, or if you wish to create a new one, see [Creating a document](#) on page 58.

3. You now have a choice: carry on to select enclosures, or further define the document usage, eg. form count, cascading, hand-feed etc. The following assumes you want to further define the document usage. When you have finished you will return to the screen shown here. Press the **Settings** button.

New - Job

1 Define mailset

2 Doc. placement

3 Fold settings

4 Mail sorting

5 Output placement

6 Output settings

7 Save job

1 Define mailset

Envelope

C5-162mm Select Settings

Main document

A4 Select Count 1 Settings

Enclosures

None Select

Cancel Previous Next Save

4. Set form count for multiples, and if required, select cascading (automatically feed from another hopper when this one runs out), or Daily Mail (hand-feed). Press the **OK** button when done. For further settings, press the **Edit Advanced** button.

New - Job

1 Define mailset

2 Doc. placement

3 Fold settings

4 Mail sorting

5 Output placement

6 Output settings

7 Save job

1 Define mailset

Envelope

C5-162mm Select Settings

Main document

A4 Select Count 1 Settings

Enclosures

None Select

Document Settings

Form count

1

Cascading

No

Hopper feed mode

Default

Edit Advanced

Cancel Save

Cancel Previous Next Save

- If you wish to choose an orientation other than the auto-selected default, un-tick the **Auto** box to enable the selector button.

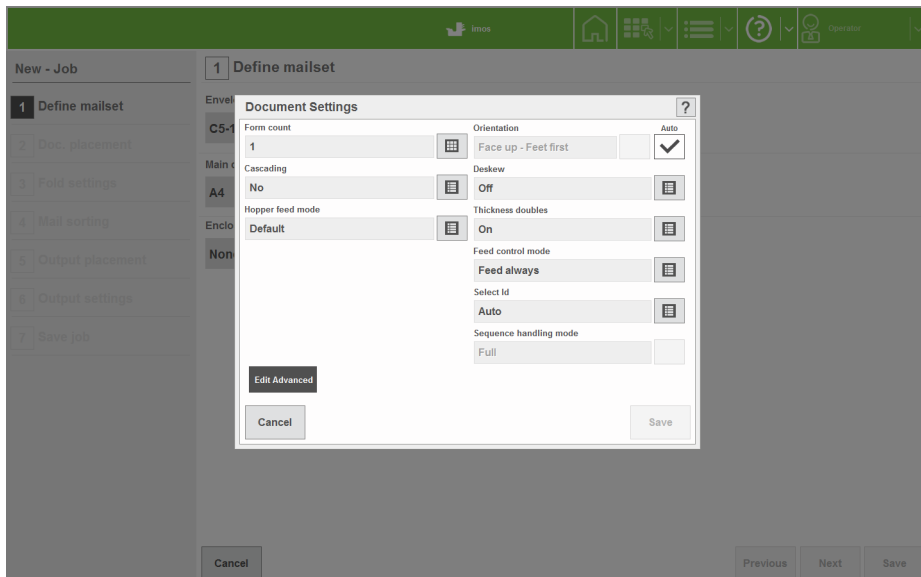

The following settings can be made:

- **Deskew:** Set low if possible; high slows machine down. Turn off if skewing is not occurring.
- **Thickness doubles:** can currently be checked optically only on a feeder folder or feeder, or turned off, if for example, documents are substantially different from the calibration document, such as abnormally dark with heavy printing.
- **Feed control mode:** is 'Feed Always' as default, but can be turned off to disable the hopper. It can also be set to 'Selective Feed' for reading-enabled units. This works in conjunction with 'Select ID' .
- **Select ID:** Defines an ID number for document to accord with the Select mark in the label. This will then feed the document when that mark is read.
- **Sequence handling mode:** how sequence marks (if used) are handled when a document set is broken up (eg. to change a job in the middle of a document set). Set to 'Full' for the first pass, then change to 'Mailset' for the second pass after the job has been changed. The machine will not then expect an unbroken sequence.

Selecting the enclosure

- If you are using enclosures (inserts, BREs, booklets etc.), press the **Select** button.

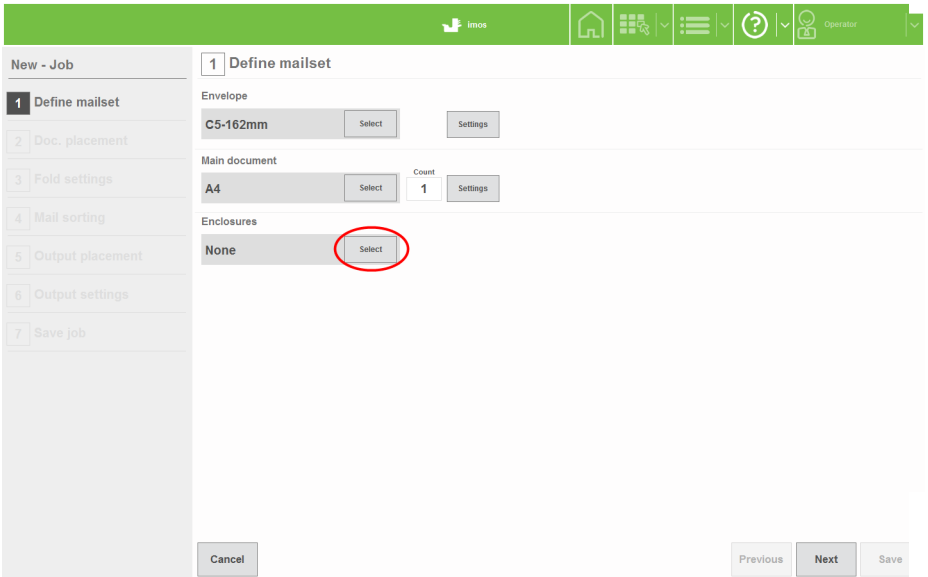

2. Select the required enclosure from the library and press the **OK** button.

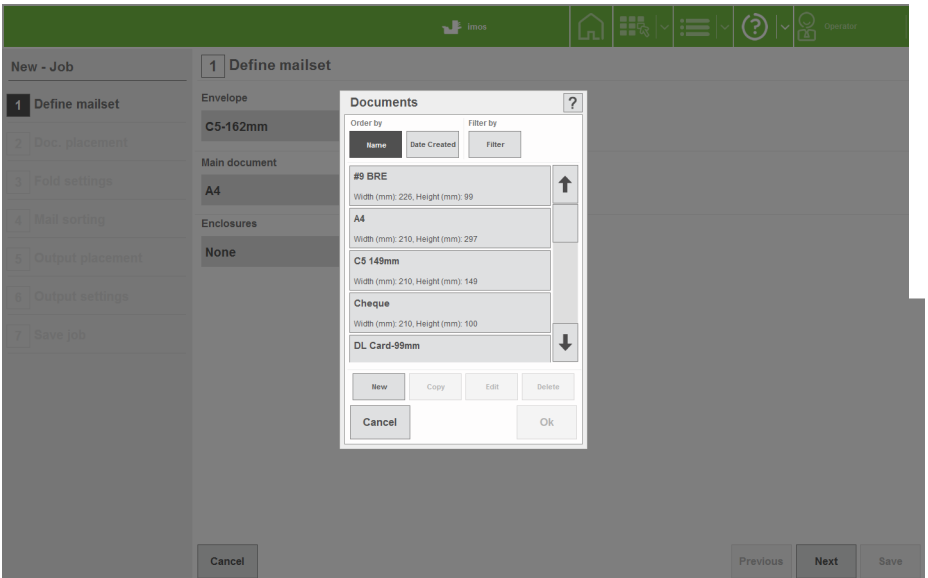

If there are no enclosures in the library, or if you wish to create a new one, see section [Creating an enclosure](#) on page 63.

3. You now have a choice: carry on to select further enclosures if required, remove the enclosure you have selected, or further define the enclosure usage, eg. form count, cascading, handfold etc.
- The following assumes you want to further define the enclosure usage. When you have finished you will return to the screen shown here.
- Press the **Settings** button. **Settings and Advanced Settings are same for enclosures as for documents-** see steps 4,5 of section **Selecting the document**

The screenshot displays the 'Define mailset' configuration screen. On the left is a sidebar with steps: 1 Define mailset, 2 Doc. placement, 3 Fold settings, 4 Mail sorting, 5 Output placement, 6 Output settings, and 7 Save job. The main area is titled '1 Define mailset' and contains three sections: 'Envelope' with 'C5-162mm' selected and a 'Settings' button; 'Main document' with 'A4' selected, a count of '1', and a 'Settings' button; and 'Enclosures' with 'DL Card-99mm' selected, a count of '1', and a 'Settings' button circled in red. A 'Remove' button is also present next to the 'Settings' button. At the bottom are 'Cancel', 'Previous', 'Next', and 'Save' buttons. The top navigation bar includes a home icon, 'imos', and several utility icons.

7

English



Documents are normally loaded in the Tower Folder face-up and feet-first if non-reading, face down and head-first if reading. **This may vary**: see also orientation chart in [Loading the Tower Folder hoppers](#) on page 71.

4. If further enclosures are required, press the **Select** button and repeat steps 1 to 4. Repeat as required up to the limit of available stations. Press the **Next** button to assign the documents/enclosures to specific hoppers.

The screenshot shows the 'Define mailset' screen in the Imos software. The interface includes a green top bar with the 'Imos' logo and navigation icons. A sidebar on the left lists steps: 1 Define mailset, 2 Doc. placement, 3 Fold settings, 4 Mail sorting, 5 Output placement, 6 Output settings, and 7 Save job. The main area is titled '1 Define mailset' and contains the following settings:

- Envelope:** C5-162mm (with 'Select' and 'Settings' buttons)
- Main document:** A4 (with 'Select' button), Count: 1 (with 'Settings' button)
- Enclosures:** DL Card-99mm (with 'Select' button), Count: 1 (with 'Settings' and 'Remove' buttons)
- None:** (with 'Select' button)

At the bottom right, there are three buttons: 'Previous', 'Next' (circled in red), and 'Save'. A 'Cancel' button is located at the bottom left.

The mailset is now defined, and the screen will show that this is ticked.

Defining the document placement settings

Only do this if you want to assign documents/enclosures to specific hoppers, otherwise press **Next**.

1. Select document to move, then the hopper to assign it to.

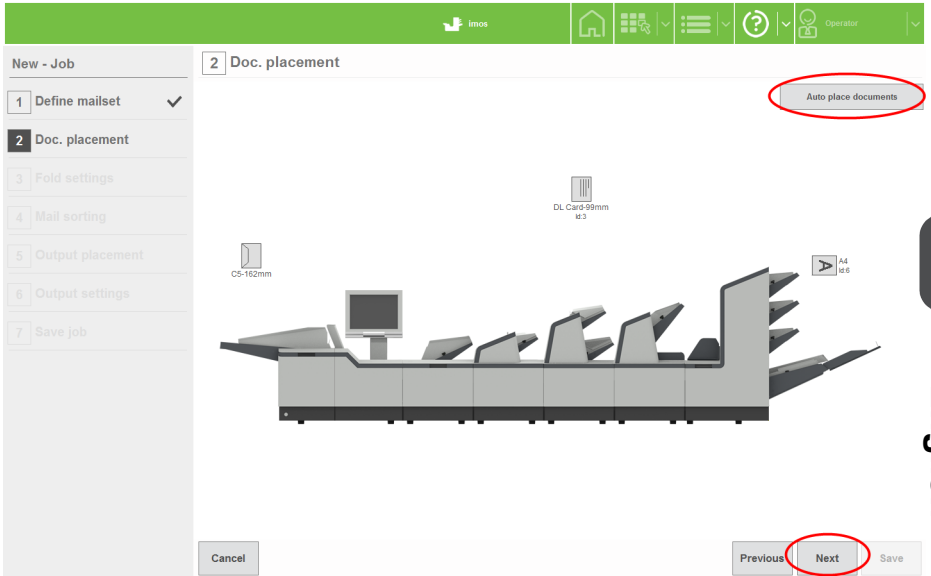

7

English

Press the **Next** button. The screen will show that document placement is ticked.

Now define the fold settings.

Defining the fold

1. The machine will automatically select the optimum fold type. If you wish to change this, deselect 'Auto' and set the required fold.

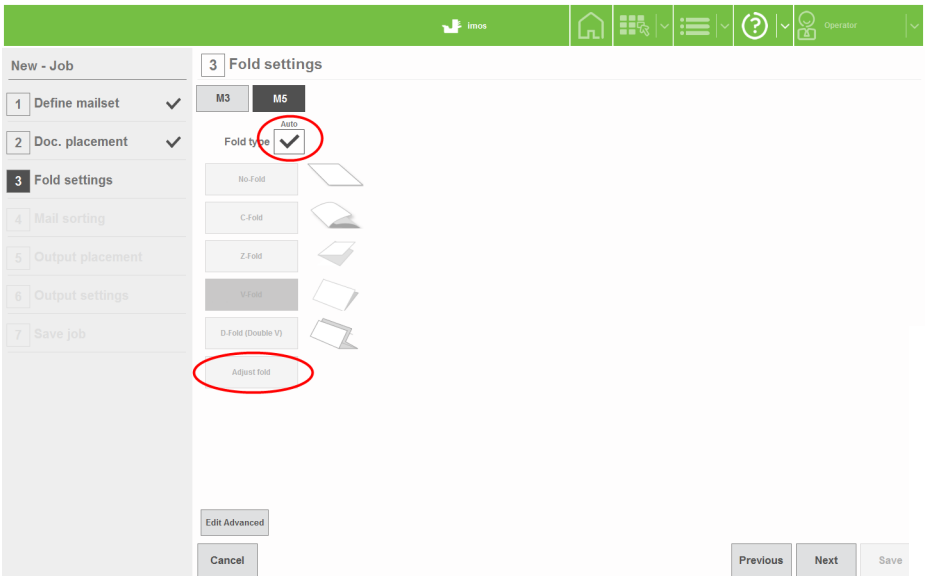

The machine may not perform properly if you change the fold type wrongly.

If you wish to make adjustments to the fold lengths, or just check them, press the **Adjust fold** button.

2. Make adjustments as required and press the **OK** button.

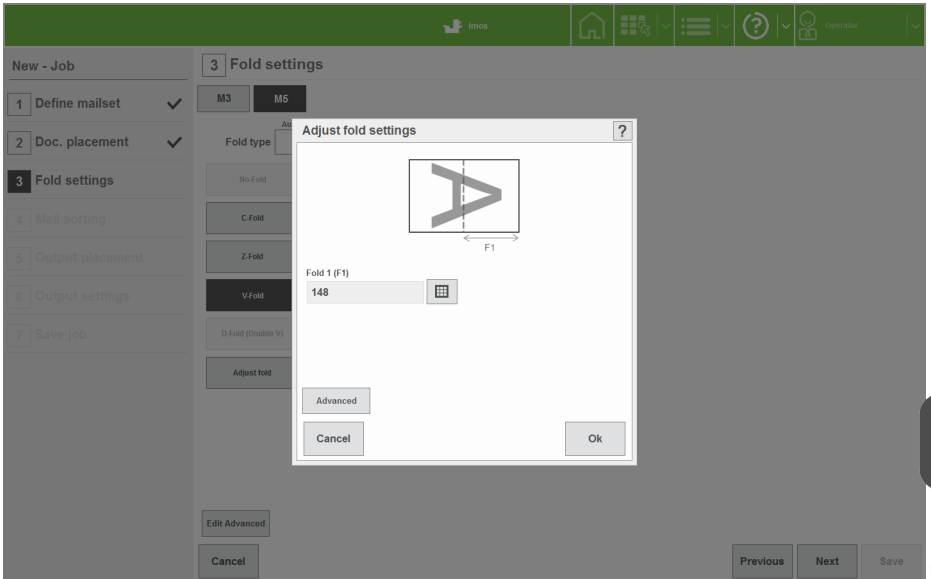

7

English



For Max. & Min. fold lengths for each fold plate, see [‘Technical Specifications’](#).

3. If you wish to make adjustments to, for example, the collation mode or Max no. of sheets folded together, press the **Edit advanced** button.

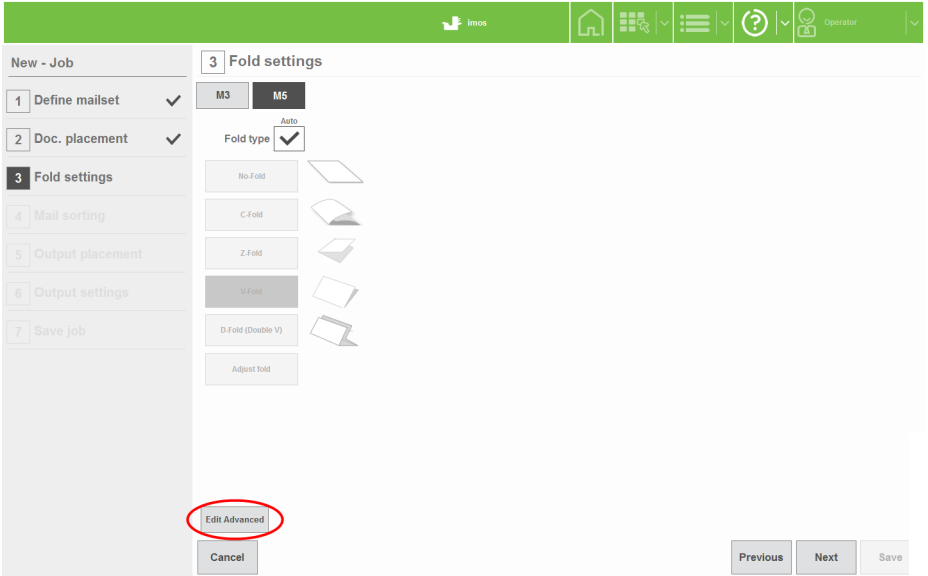

7

English

4. The following advanced settings can be made:

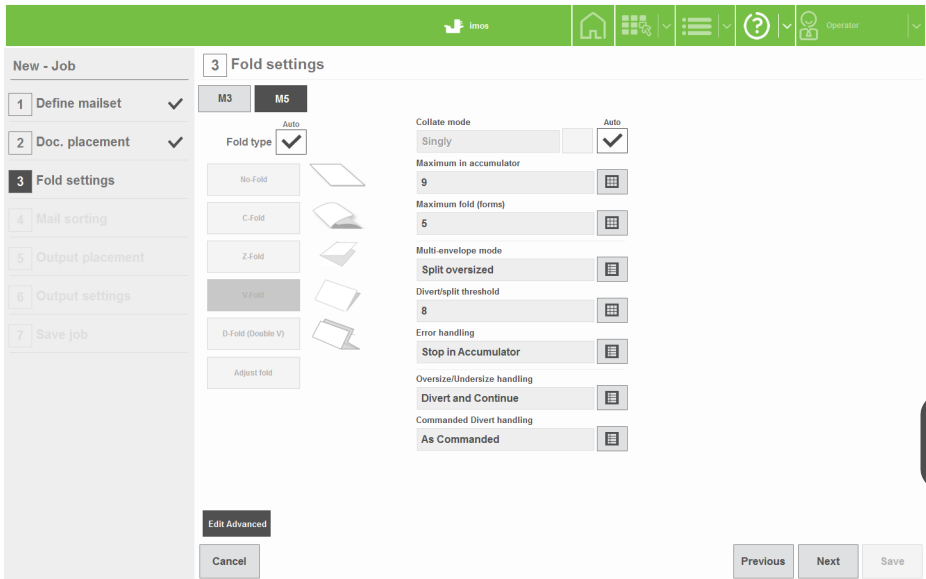

- **Collate Mode:** when ticked the collate mode is set to '**Singly**': folds sheets one by one. When un-ticked you can choose between:
 - **Together:** collates forms and folds them together.
 - **Together via Accumulator:** is as above, but feeds into accumulator before folding.
- **Maximum in accumulator:** Up to 25 depending upon the paper type.
- **Maximum Fold (Forms):** Number of forms that can be folded together. Groups bigger will split into a) max number, followed by b) remainder.
- **Multi-envelope mode:** Allows two separate jobs to be run in succession using the same document set.
 - If set to **Split Oversized**, this splits, folds and inserts as for 'Maximum Fold' described above.
 - If set to **Divert Oversized**. All groups more than number set in **Divert/Split Threshold** will be diverted. For **Divert Undersized**, the same applies for groups below the threshold. Machine is then stopped, job is changed and forms in divert tray are replaced into the document set, and the new job is run. See also Table 1 below.



If **Divert Oversized/Undersized** is selected, **Divert/Split Threshold** must be set to the same as **Maximum Fold (Forms)**.

- **Error handling:** Action of machine after bad reads.
- **Oversize/Undersize handling:** Action of machine after diverting as above.



Not available if **Split Oversized** is set.

Table 1**Handling of folded forms**

Shown below are handling of oversized/undersized groups under different circumstances.

Multi envelope mode	Maximum Fold	Maximum in accumulator	Divert/Split threshold	Comment
Split oversized	When folding, the group or sub-group is folded on reaching this limit	When not folding or diverting, the group or subgroup is ejected towards divert or head unit on reaching this limit	Not used	Mechanical limits of folder and accumulator for given stationery
Divert oversized	Not used (As for Split Oversize if oversize not yet detected).	Not used (As for Split Oversize).	The complete group is assembled in the accumulator and then diverted if prime document count is equal or greater than this limit	Typically used for diverting large groups for re-processing into a larger envelope
Divert under-sized	Not used (As for Split Oversize if undersize not yet detected).	Not used (As for Split Oversize).	The complete group is assembled in the accumulator and then diverted if prime document count is less than this limit	Typically used for diverting small groups for re-processing into a smaller envelope

Fold settings are now complete. Press the **Next** button, the screen will show that this is ticked.

Defining the output settings

1. Set the settings for **Batching**. By default Batching is set to off.

New - Job

6 Output settings

Batching

Batch

Batch Off

Batch mode

Batch and Continue

Batch quantity

200

Batch complete pause time (s)

3

Cancel

Previous Next Save

7

English

- Set **Batching** to Batch On if required and set required quantity in **Batch Quantity**. Set **Batch Mode** as follows:

Batch and Continue:

Machine will pause for the specified pause time, and then resume.



Conveyor will continue to run during the pause time.

Batch and Stop: Machine will stop and resume only when the Run button is pressed.

Select **Envelope Count** under **Batch Control**, currently the only available option.

Set the **Batch Complete Pause Time** as described in **Batch and Continue** above.

- If a conveyor is fitted, select **Conveyor Settings** to adjust the Jog functions as follows:
 - **Single Jog Adjust:** Adjusts default jog step (gap) between mailpieces. Note that steps are unitless.
 - **Batch Complete Jog Step:** Adjusts gap before machine performs action described in 'Batch Mode'.
 - **Mark Reading Jog Step:** Adjusts gap created after Jog mark is read.
 - **Autoend Jog Step:** Adjusts gap created before machine autoends.

Output Settings are now complete. If you are using Mail Sorting or Franking, refer to the [INF Appendix](#).

Press **Next** and the screen will show that this is ticked. You can now save the job.

Saving the job



Any of the Job Creation screens can be edited by pressing **Edit** for the selected job in the Job screen. Note that the **Save** button will then be enabled on each screen.

1. Press the keyboard icon to display the virtual keyboard.

The screenshot shows the 'New - Job' configuration screen. A green header bar at the top contains the 'imos' logo and navigation icons for home, keyboard, list, help, and operator. The main content area is divided into a left sidebar and a right main panel. The sidebar lists seven steps: 1. Define mailset, 2. Doc. placement, 3. Fold settings, 4. Mail sorting, 5. Output placement, 6. Output settings, and 7. Save job. Step 7 is currently selected. The main panel shows the 'Save job' form with fields for Job name (New name), Job description, Job number control mode (Not used), Job number, AIMS mode (Off), and Datalogging mode (Standard). Each field has a keyboard icon to its right. At the bottom, there are three buttons: 'Cancel', 'Previous', and 'Next'. The 'Save' button is circled in red.

7

English

- Enter a name for the job using either the virtual or physical keyboard.

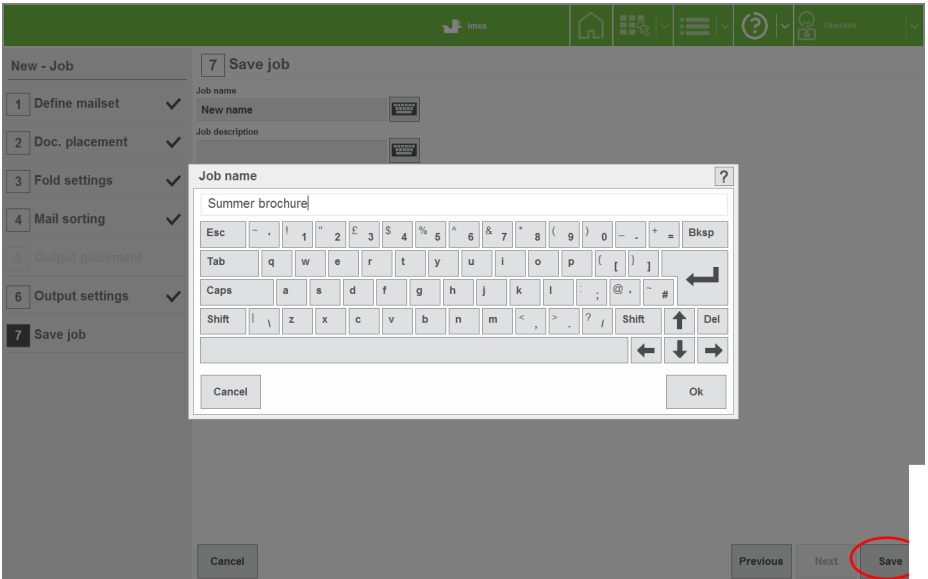

- Repeat steps 1 & 2 to enter a brief description for the job. This is the description that will appear in the job list when the machine is started.
- Set the **Job number control mode**. Options are Auto generated; Manual entry (Internal or External); Read from prime; Read on output; Externally supplied.

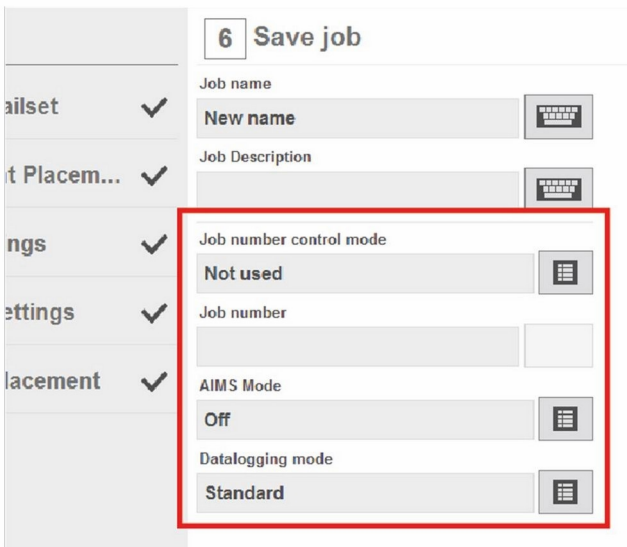

- Enter a **Job number** if manual entry control mode is being used. Disabled for all other modes.

6. Set the **AIMS Mode**. Options are Off; Statistics; Audit; Verification; Lookup (FBM).
7. Set the Datalogging Mode. Options are Off; Standard; AIMS Statistics Compatible.
See also AIMS User Reference Guide for full details.

You have now successfully created a new job and it will appear in the job list.

Creating an envelope

In order for an envelope to appear in the envelope library, it must first be created.

1. Begin creating a job (see [Creating the Job Settings](#) on page 33).
2. At the point where you need to select an envelope, press the **New** button.

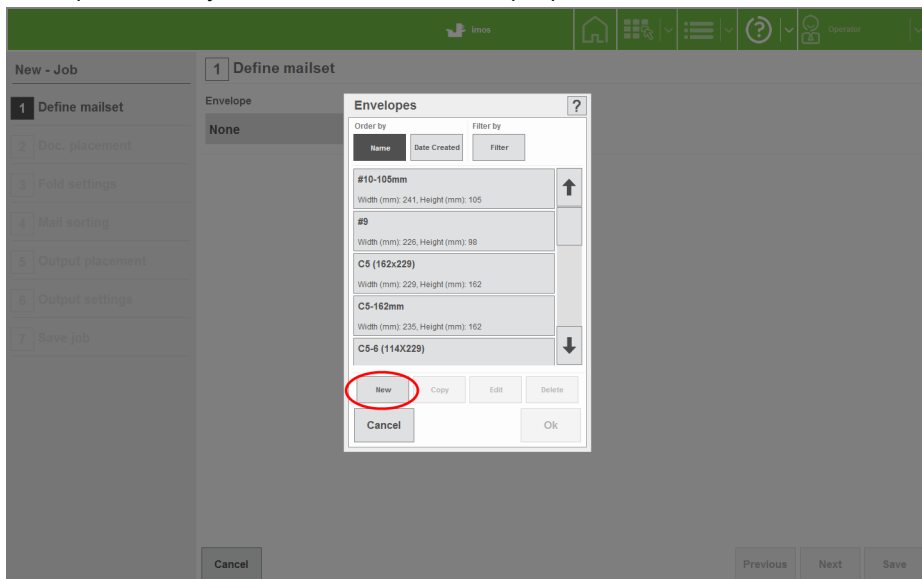

7

English

3. Enter a name for the envelope: press the virtual keyboard icon and enter the name using either the physical or virtual keyboard. Select an envelope size. The default width and height for that type will then be shown. If you want to adjust the size, the size will change to 'Custom'. Adjust the flap depth if required. If you want to adjust the envelope weight and the wetting rate, press the **Edit Advanced** button.

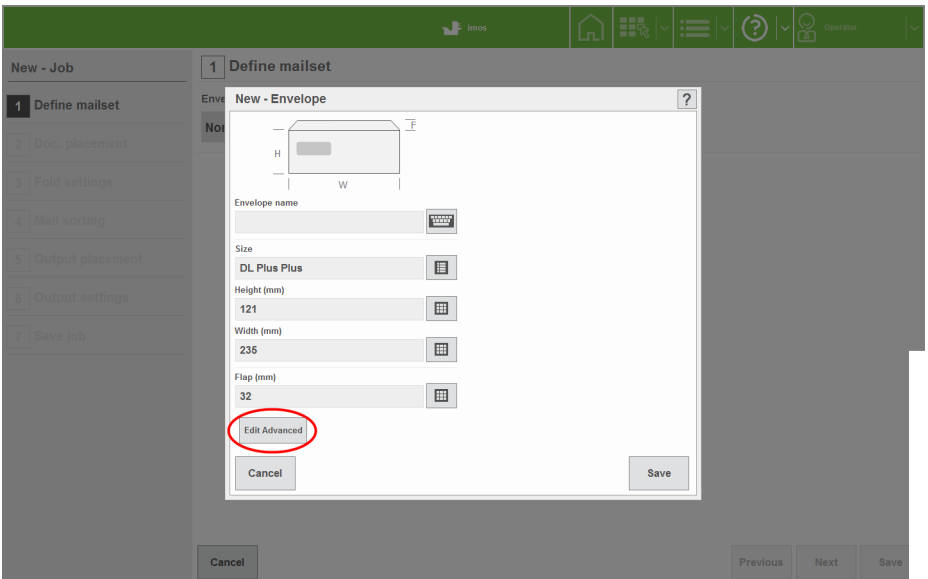

7

English

- Adjust the weight as required. Note that the weight is the actual weight of the envelope, not the paper weight. Adjust the wetting rate if required. The number shown is the quantity of envelopes sealed before the pump tops up the wetter tank. Default is 25. Press the **Save** button when done. The envelope will now be available in the envelope library under the name you have given it.

The screenshot shows a software interface for defining a new envelope. The main window is titled 'New - Job' and has a sidebar with steps: 1. Define mailset, 2. Doc. placement, 3. Field settings, 4. Mail sorting, 5. Output placement, 6. Output settings, 7. Save job. The 'Define mailset' step is active. A dialog box titled 'New - Envelope' is open, showing a diagram of an envelope with dimensions H, W, and F. The fields are: Paper weight (80 gm), True weight (4.55 g), Envelope name (Computed), Size (DL Plus Plus), Wetting rate (25), Height (121 mm), Width (235 mm), and Flap (32 mm). There are 'Edit Advanced', 'Cancel', and 'Save' buttons.

7

English

The envelope is now fully defined and is available for use.

Creating a document

In order for a document to appear in the document library, it must first be created.

1. Begin creating a job (see [Creating the Job Settings](#) on page 33).
2. At the point where you need to select a document, press the **New** button.

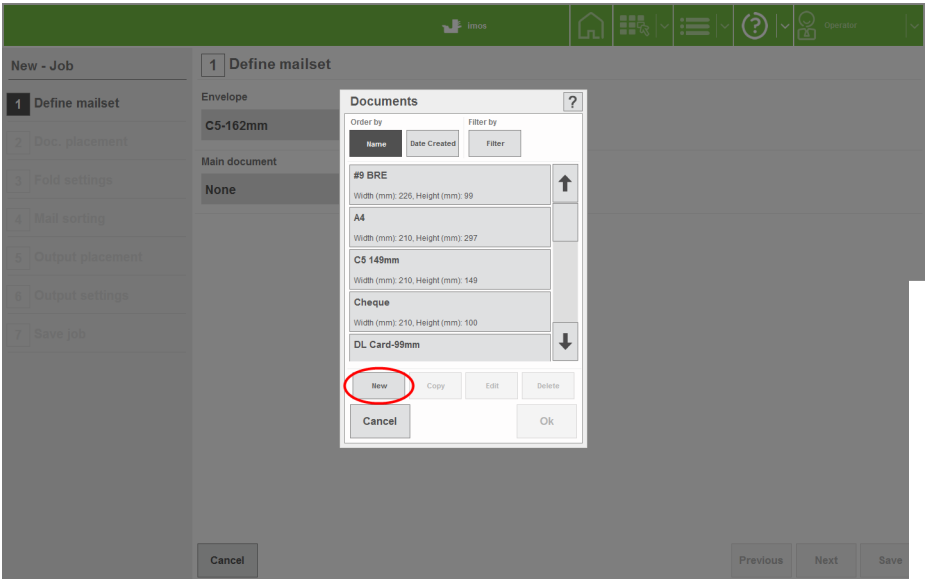

7

English

3. Enter a name for the document: press the virtual keyboard icon and enter the name using either the physical or virtual keyboard. Select a form type and size and orientation. The default width and height for that type will then be shown. If you want to adjust the size, the form type will change to 'Custom'. Change the thickness for thick documents, eg. booklets. If you want to make further adjustments, or select a reading definition, press the **Edit Advanced Button**.

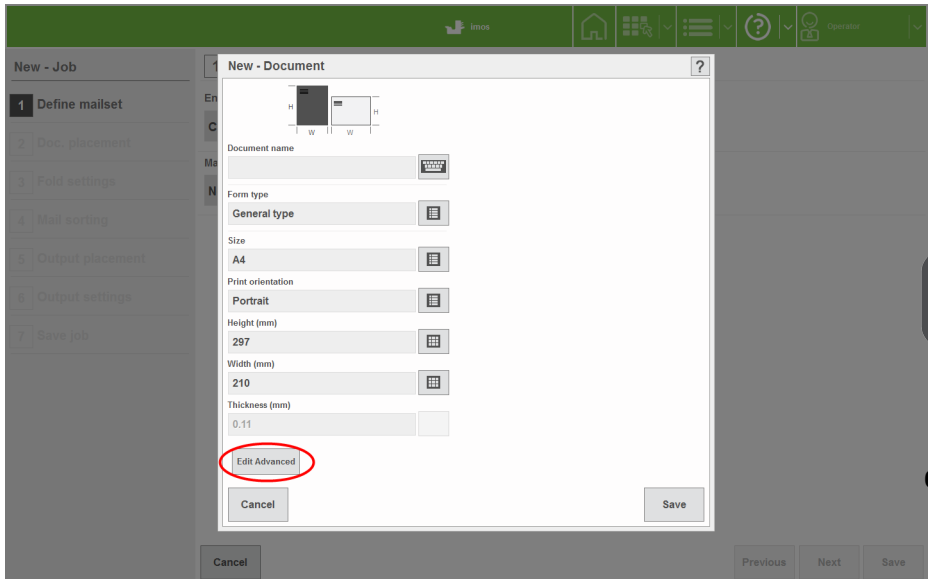

4. Select the address position. This defaults to 'Top'; specify middle, bottom or none if required.

Specify whether the document is to be folded (eg. a booklet would not be) and its thickness and weight. Note this is the actual weight of the document, not the paper weight.

The thickness is more applicable to booklets - if no figure is specified, 80gsm paper will be assumed.

If the document uses an OMR or barcode label, select a reading definition.



This is obtained under licence as an option and must already exist on the machine.

7

English

The screenshot shows the 'New - Document' dialog box with the following settings:

- Address position: Top
- Foldable: Yes
- Paper type: Standard
- Paper weight (gsm): 80
- True weight (g): 4.99
- Size: A4
- Print orientation: Portrait
- Height (mm): 297
- Width (mm): 210
- Thickness (mm): 0.11
- BCR definition: None
- OMR definition: None
- Region of interest: (circled in red)

Buttons: Edit Advanced, Cancel, Save.

If the document does not use an OMR or barcode label, press the Save button, otherwise, proceed as follows.

- Press the **Region of Interest** button to specify the position of the label. Specify **Manual** for Detection Mode only if specifically required. By selecting **Auto**, the label position will automatically be detected. If multiple labels are present, a dialog box will open when the job is run, allowing the operator to select the required label.

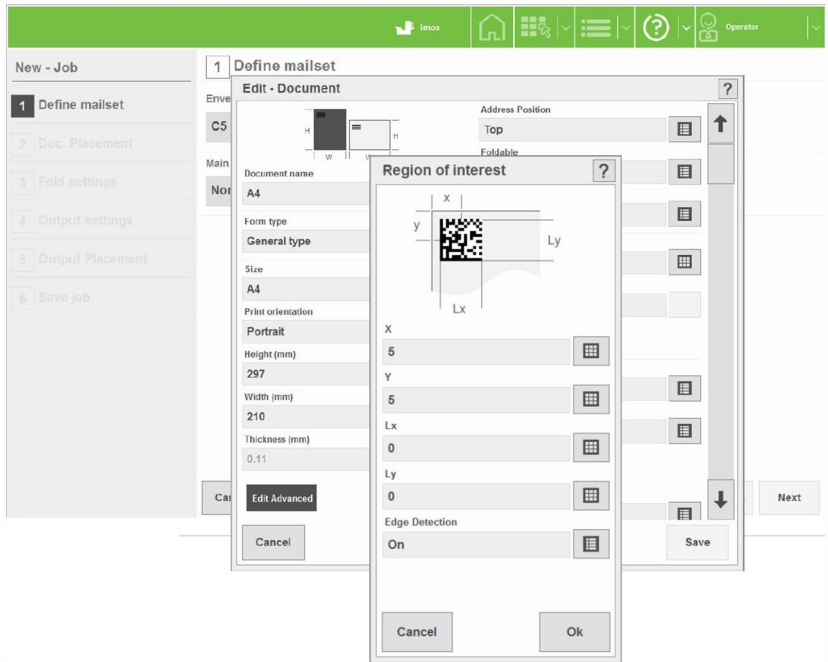

6. Specify the position of the label and select whether edge detection is required – this detects the edge of the paper and should normally be **On**.
Turn Off if coloured or densely printed paper is giving false readings: the machine will then use default dimensions for label position. Press the **Save** button when done.

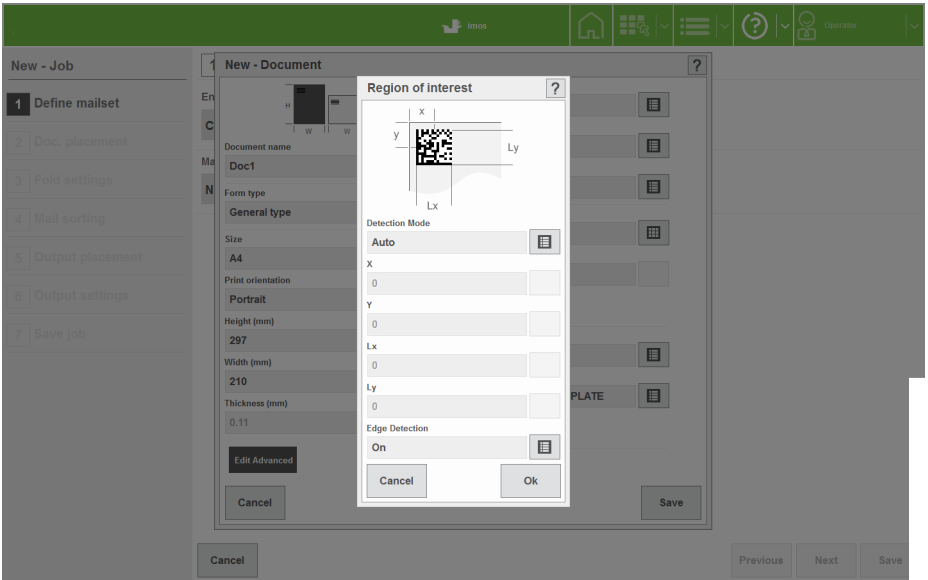

The document is now fully defined and is available for use.

Creating an enclosure

In order for an enclosure to appear in the enclosure library, it must first be created.

1. Begin creating a job (see [Creating the Job Settings](#) on page 33).
2. At the point where you need to select an enclosure, press the **New** button.

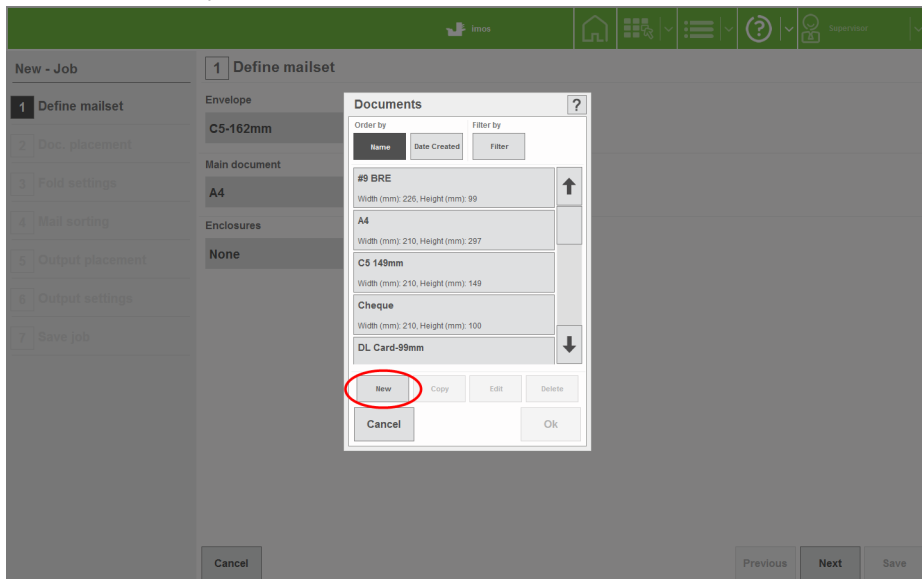

7

English

- The procedure for defining an enclosure is the same as that for a document, described in [Creating a document](#) on page 58. It is the document type that you select that determines whether it appears in the document or enclosure library. See [Creating a document](#) on page 58 for the remainder of the settings.

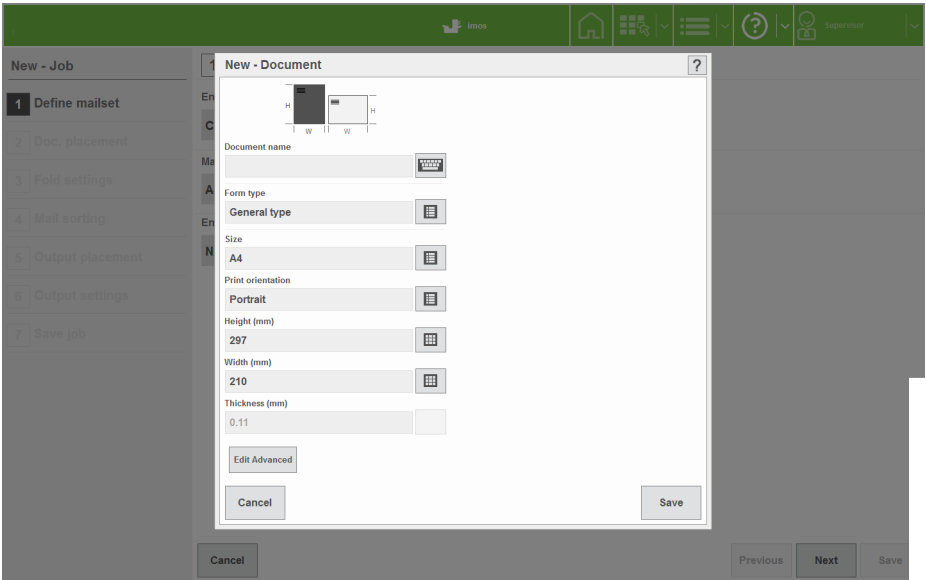

The enclosure is now fully defined and is available for use.

8 Loading the paper hoppers

Loading the envelope hopper

1. Using the black knob, adjust the side guide to give 1-1.5mm clearance each side of the envelope.

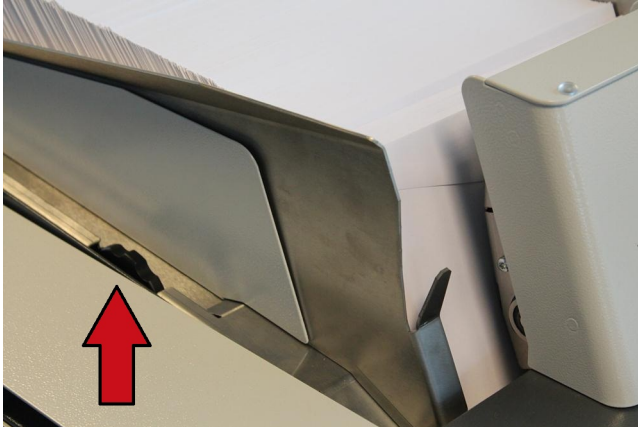

2. Adjust the angle of the backrest (see below) and load the envelopes into the hopper, flaps forward, so that the lower edges follow the contour of the surface and down into the pick-up roller. Move the backrest forward (see below) so the envelopes are fully forward, but not tightly packed.



3. Move the backrest forward by squeezing the handle upwards to release the rollers from the track.
Adjust the width of the panels to suit the envelope.
Adjust the angle by slackening the knob each side.
C5: Fully raised
DL/DL+: Fully lowered

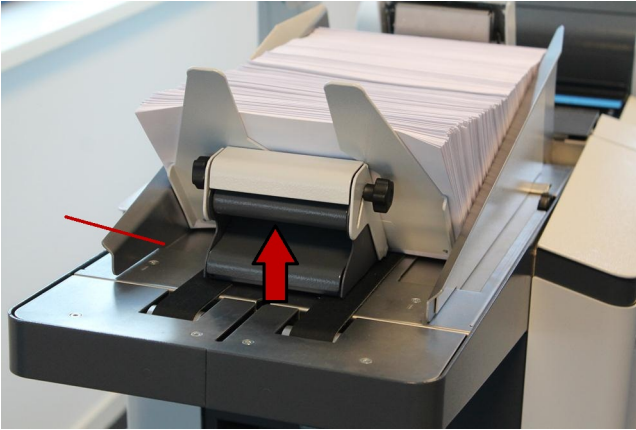

If the envelope feed is not consistent, try a backrest angle in-between.

Adjusting the envelope separator

1. To adjust the separator, open the side cover on the insertion head; the adjustor knob is visible below the envelope conveyor. Turning clockwise decreases the gap, anti-clockwise increases it.

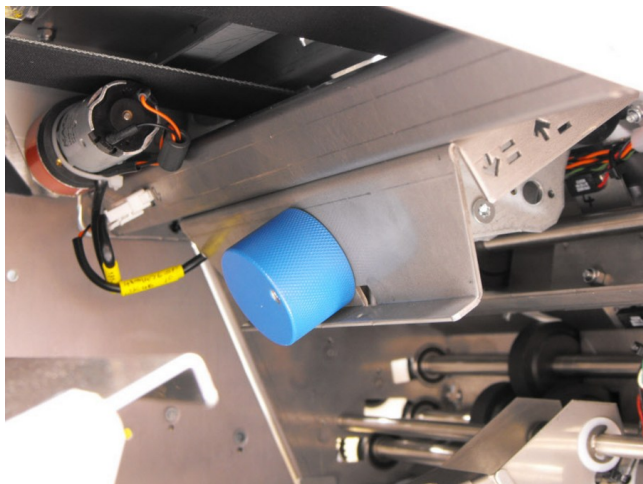

2. To set the separator gap, empty the hopper, then slide an envelope into the gap and turn the knob until the separator will just grip the envelope as you withdraw it.
 3. Close the side cover when you have finished.
-

Loading the feeder hopper

1. Move the guides to give 1 - 1.5mm clearance each side of the insert.

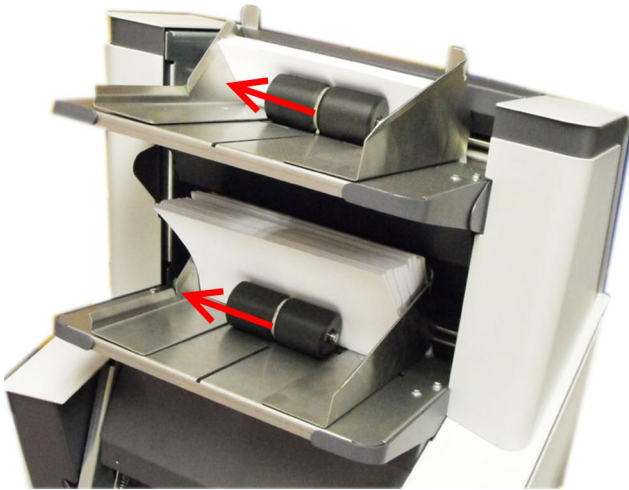

2. Draw back the weighted rollers and load the insert pack so that the leading edge is feeding into the nip of the feed rollers. Move the weighted roller forward to support the pack.



Twin feeder is shown; single feeder is similar, with one hopper only.

Adjusting the separator

The separator prevents more than one enclosure being fed at a time.

1. **Feeder:** The feeder separator has 4 settings, marked A to D on the slide, or A - C for Twin Feeder). Before running the job, the gap must be set to suit the thickness of material being processed - this prevents more than one item being fed at a time. Note

that there is an intermediate setting between each marked position, allowing finer adjustment.

Slide positions:

A = 0 to 0.75mm

B = 0.75 to 1.5mm

C = 1.5 to 2.5mm

D = 2.5 to 4.0mm

(A - C only on Twin Feeder)

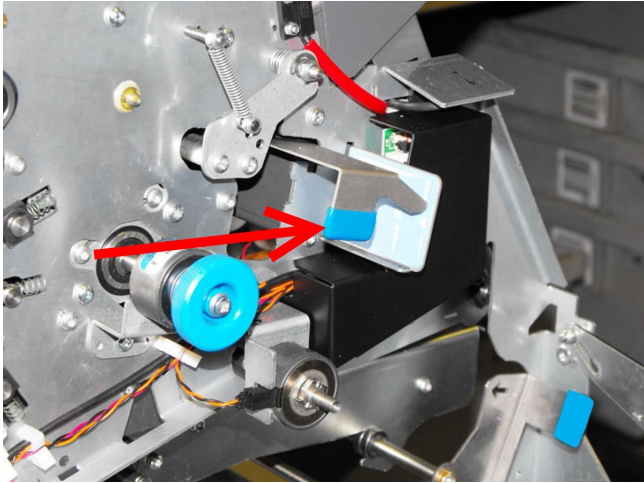

Most jobs will use position A. If you use the wrong setting, an error will appear on the control panel.



For problem enclosures, the feed rollers can be changed to optional alternatives.

- Feeder Folder:** To increase the separator gap, turn the adjuster wheel downwards (clockwise). Turn it the other way to decrease the gap.

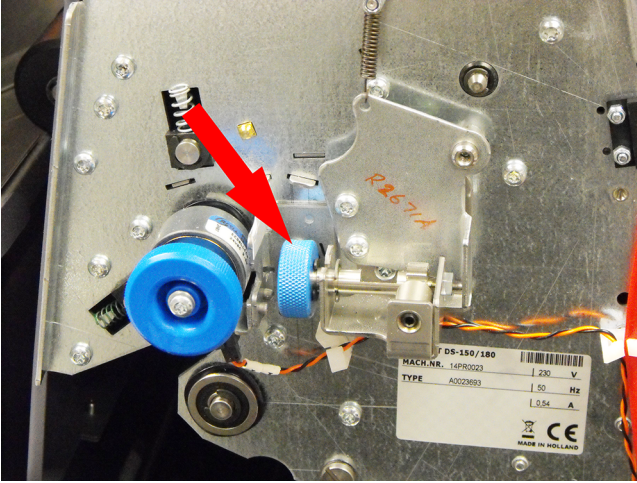

Loading the tower folder hoppers

The tower folder may be fitted with 500-sheet or 1000-sheet hoppers. The example shown has 1 x 500-sheet and 1 x 1000-sheet hoppers.

1. On 500-sheet hoppers, slacken the black knob next to the side guides (arrowed) and move the guides to give 1-1.5mm clearance each side.

On 1000-sheet hoppers, press down on the tray to lower it. Slacken the black knob above the hopper (arrowed) and use the tabs to move the guides to give 1-1.5mm clearance each side. The tray will raise automatically when the machine is started.



2. Tighten the knobs.

Collator

If the Tower Folder is fitted with an accumulator, the side guides must be adjusted to suit the paper - use the preset size markings to set the paper width.



1. Raise the top of the accumulator so that it locks in place and place a piece of paper between the side guides.
2. Slacken the black knob next to the side guides (arrowed) and move the guides to give 1-1.5mm clearance each side.
3. Pull out the handle at the end (arrowed) to lower the accumulator top.

Adjusting the separator

The separator prevents more than one document being fed at a time.

1. Open the side cover on the operator side and turn the knob in the required direction to open or close the gap. The markings next to the knob indicate which direction to turn it.



2. To set the separator gap, empty the hopper, then slide a form into the gap and turn the knob until the separator will just grip the form as you withdraw it.
-

Daily Mail Tower Folder

Daily Mail

Daily mail allows a group of forms to be hand-fed, folded and inserted on a Tower Folder. A group of forms up to a total of 6mm thick may be fed, but be aware of the folding capacity of 8 forms of 80gsm (20lbs bond). The forms may be stapled or not, as required. See below for stapling restrictions.

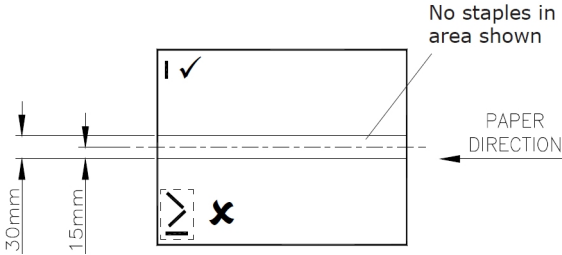

8

English

Using Daily Mail

To use daily mail, define a new mailset (as described in [Defining the mailset](#) on page 34) or edit the document settings in an existing job.

Select **Settings** for the document and set 'Hopper feed mode' to **Daily Mail**.

The screenshot shows the software interface for defining a mailset. The 'Define mailset' dialog box is open, showing the 'Envelope' set to 'C5-162mm' and the 'Main document' set to 'A4'. The 'Count' is set to '1'. The 'Settings' button is circled in red. Below the 'Define mailset' dialog box, the 'Document Settings' dialog box is open, showing the 'Form count' set to '1', 'Cascading' set to 'No', and 'Hopper feed mode' set to 'Default'. The 'Daily mail' option is circled in red. The 'Edit Advanced' button is also visible.

Set the accumulator tray

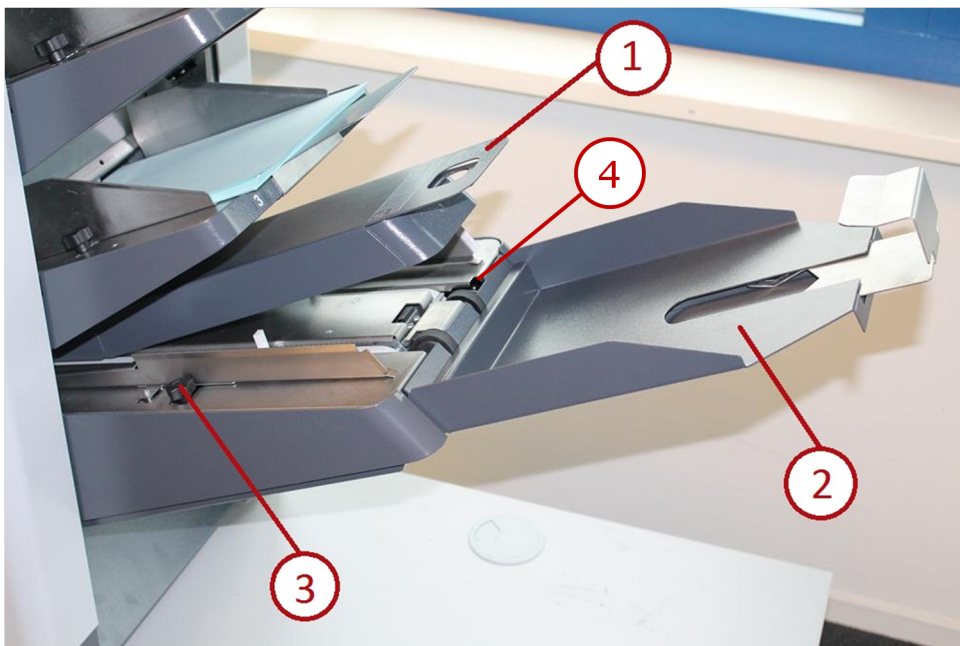

- Raise the overguide (1) until it latches in place.
- Unhook the divert tray (2) and remove it to make it easier to feed the paper.
- Slacken the knob (3) and adjust the side guides to suit the paper.

Auto and manual feed mode

When daily mail has been enabled as described feed the post into the accumulator tray and press the **Run** button in the Run screen. A pop-up screen will appear where you have the possibility to select the Daily Mail Feed Mode:

- **Auto feed:** Document automatically feeds after small delay.
- **Manual feed:** Pass finger over divert sensor (**4**) to feed document.

The machine will wait for 30 seconds after pressing the button - if you exceed this before inserting the documents, press the button again.

To turn the function off, switch 'Hopper feed mode' back to Default in Document Settings.



You may find it easier to feed the paper by unhooking the divert tray and removing it.



Manual feed is advised when using smaller documents.

Adjusting the catch tray

If a Catch Tray is being used for ejected envelopes, it should be adjusted to suit the ejected envelopes.

1. Slacken knob under side guides, and adjust to 2mm clearance each side. Tighten knobs.
 2. Lift and pull backstop, adjust to suit 'bounce' of ejected envelopes.
-

9 Operator Maintenance

General Cleaning

- Clean all paper transport rollers using water or recommended cleaning fluid, as instructed by the service engineer.
- Clean all sensors with approved air dusters (both Transmitter and Receiver if applicable. See section below).
- Clean all covers and touch screen.

Cleaning the sensors

The optical sensors consist of two halves: emitter and receiver. These can become obstructed due to paper dust and should periodically be cleaned using a nonflammable airduster (Part No. 9103707C). Both halves must be cleaned.

This section shows where the sensors are located. For most sensors, an indicator arrow is pierced showing you where the jet of the airduster should be directed. For some sensors, the retaining bush is visible next to the lens: ensure you spray into the lens, not the bush.

Cleaning the sensors



Sensors are retained with a bush next to the lens: where this is visible, ensure that you spray into the lens (arrowed), not the bush.

Insertion head

Direct the airduster into the openings arrowed and spray liberally.

1. Open the perspex top cover and raise the collate clamshell (closest to the envelope hopper) so that it locks in place.

Picture shown is viewed looking inside the collation area towards the envelope hopper

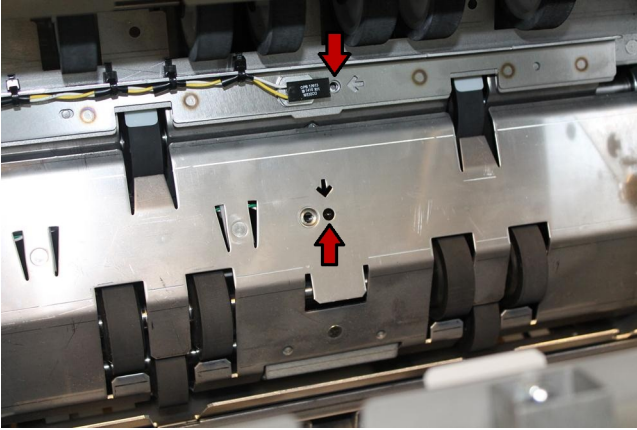

2. Picture is viewed looking inside the collation area away from the envelope hopper. Clean all sensors arrowed.

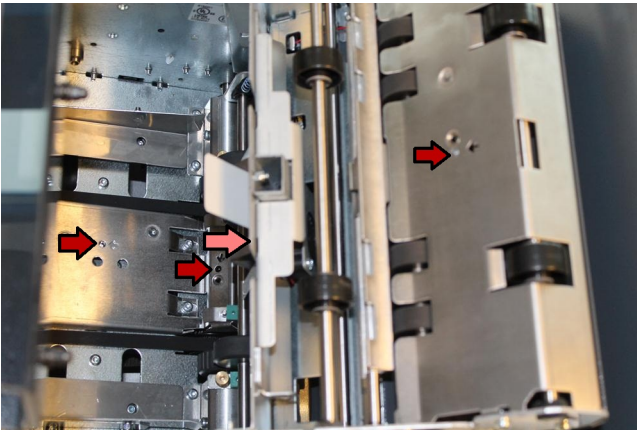

3. Lower the collate clamshell and open the upper conveyor (furthest from the envelope hopper) so that it locks in place.
Picture is viewed looking inside the collation area away from the envelope hopper.
Insert the airduster nozzle deep into the hole and spray liberally. Note the the upper sensor half is not easy to see and is mounted on a bar.
Lower the conveyor.

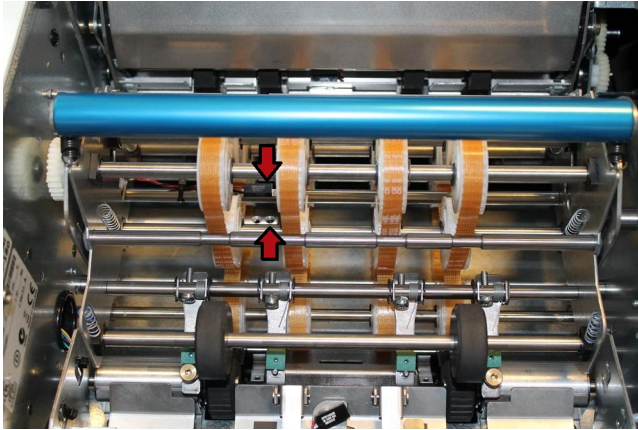

4. Lower the side cover and raise the overguide inside the closer cavity, latching it in place.
Clean the sensors arrowed.

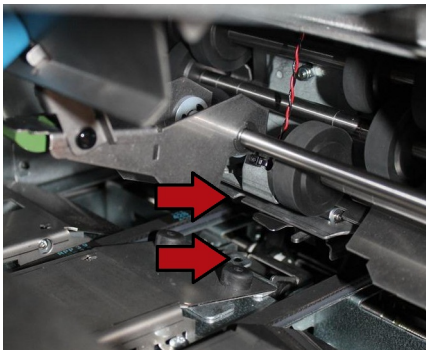

5. Picture is viewed looking down on the envelope hopper, at the front. Clean the one-piece reflective sensor.

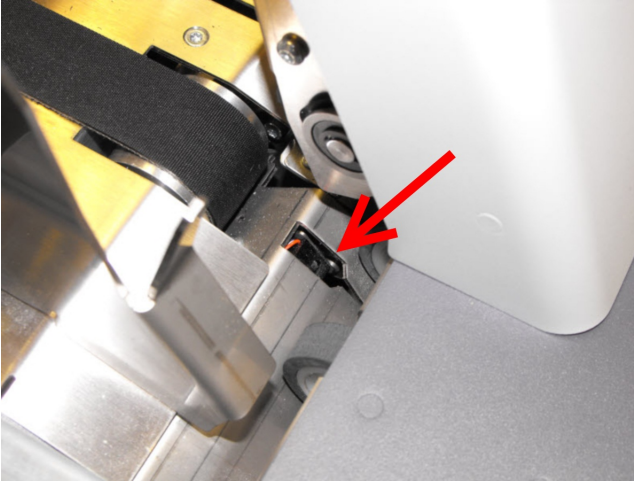

6. Lower the front output cover below the envelope feeder. Clean the sensors indicated. Note that the upper sensor is in two halves. The lower sensor is a one-piece reflective type.

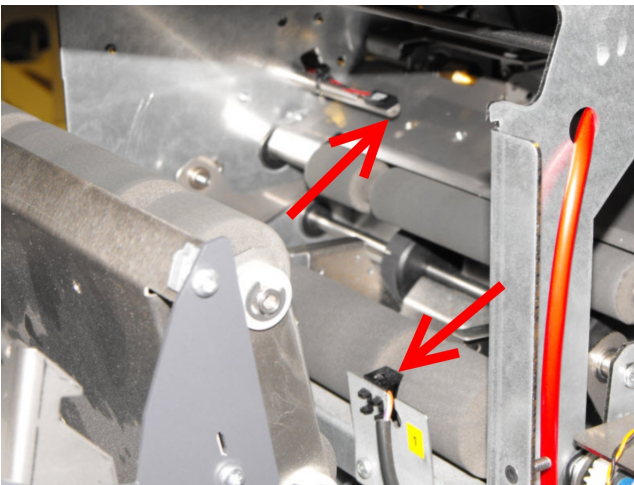

Feeder

There is a sensor on the feed hopper of a feeder, and a pair located in the lower conveyor section.

1. Remove all paper from the feed hopper and direct the airduster into the cutout indicated.



2. Open the side cover and push the lowermost lever forward to lower the conveyor. Clean the sensor located next to the gearwheel in the centre of the track as shown, with the upper half directly above it.

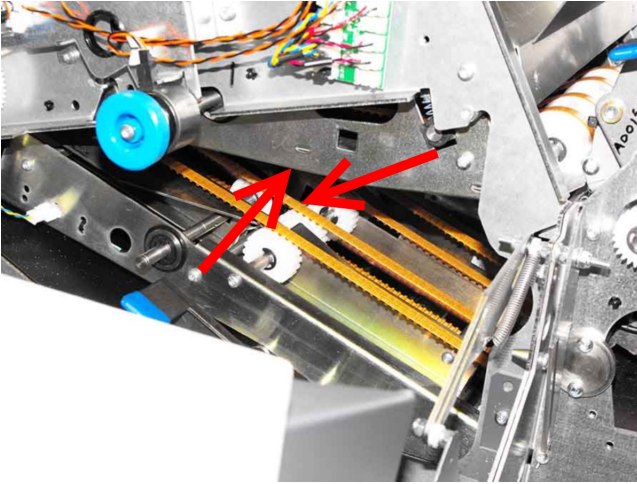

A single feeder is shown, twin-feeder is similar. Conveyor sensor applies also to feederfolder.

Feeder-Folder

There is a sensor in the front transport assembly on a feeder-folder, and another two on the top. There is also one in the lower conveyor (see Feeder).

1. Raise the cover at the front of the feederfolder. Using the blue tab, release the latch of the transport assembly and lift it upwards. Direct the airduster into the cutouts indicated.

Ensure the lever is fully latched when closing.

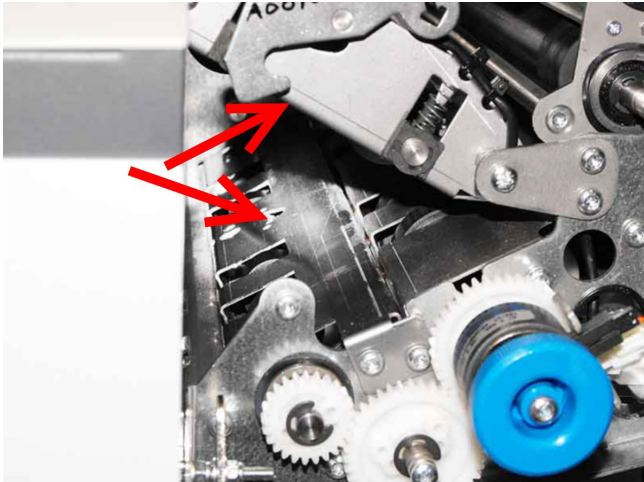

- 2. Raise the top cover. Direct the airduster into the cutout (the lower sensor in the picture), and into the gap to clean both halves of the upper sensor.

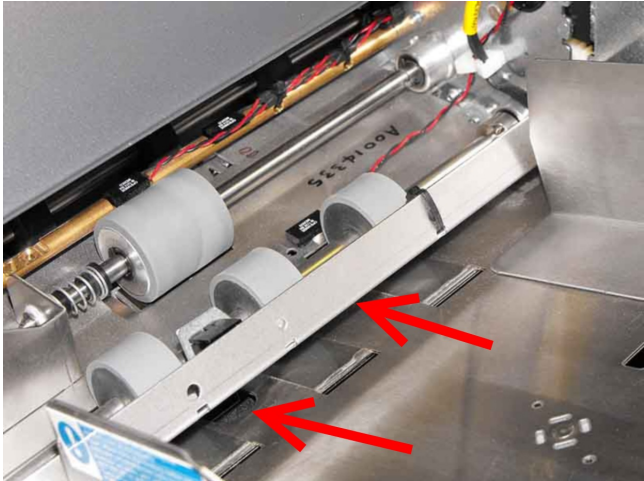

Tower Folder

1. Open the folder top cover and clean the sensors indicated. Direct the jet into the gap under the sensors, or into the hole indicated.

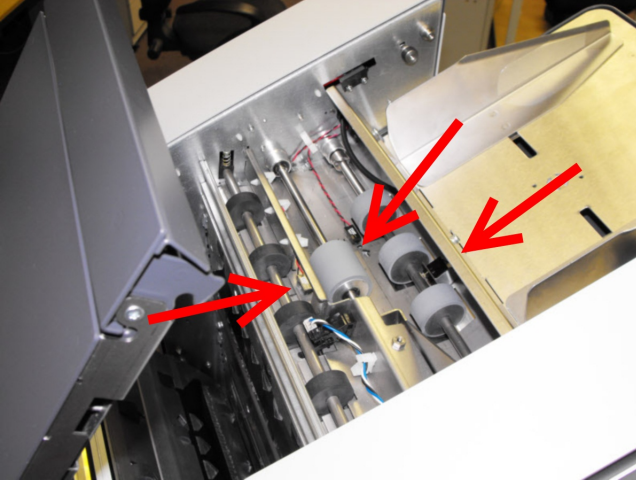

2. Open the top cover open, direct the jet into the holes indicated.

Note: The sensors are in two halves, with the opposite halves located in the cover.

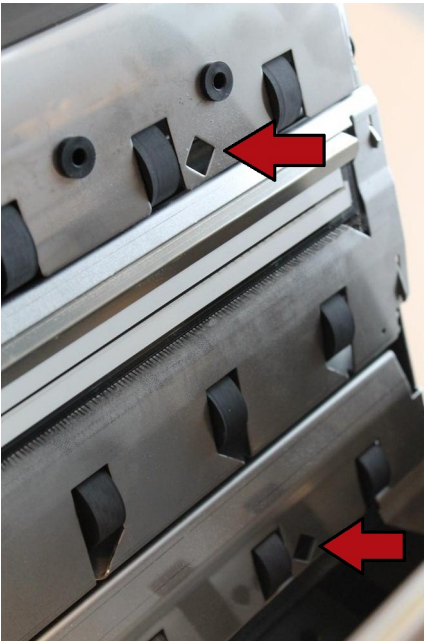
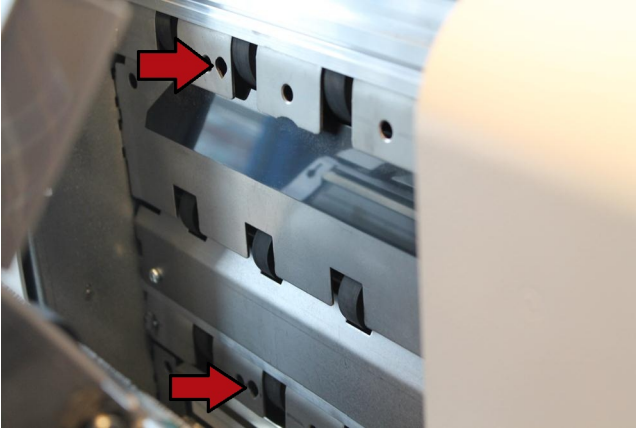

Clearing paper jams

If paper jams occur, the area affected will normally be shown in the error message on the screen. Use one of the clearance methods described below to clear the jammed paper.

Inserter Head

1. Open the side cover on the operator side of the machine, and lower the front sealer cover.

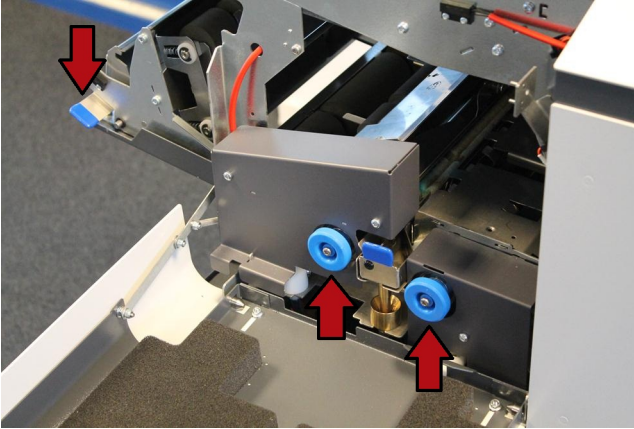

Check for jammed paper in the open cavities.

If the paper is not fully visible, turn the blue knobs to wind it into view.

Open the front closer cover using the blue tab and check for jammed paper.

Feeder (Single and Twin) & Feeder Folder

1. Open the side cover on the feeder.

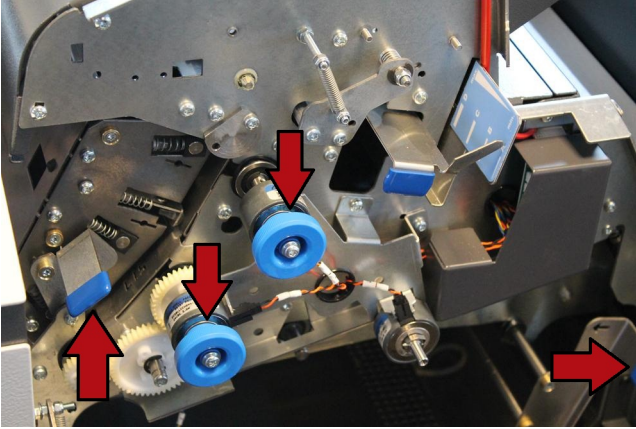

Use the blue tabs to push forward the levers indicated to open the cavities and access the jammed paper.

If the paper is not fully visible, turn the blue knobs to wind it into view.



Single Feeder is shown; Twin Feeder and Feeder Folder are similar.

Tower Folder

1. Open the side cover on the Tower Folder Base Unit.
Using the blue tab, open the folder assembly to access the jammed paper.
If the paper is not fully visible, turn the blue knobs to wind it into view.

When closing the folder assembly, ensure it is fully latched on both sides.

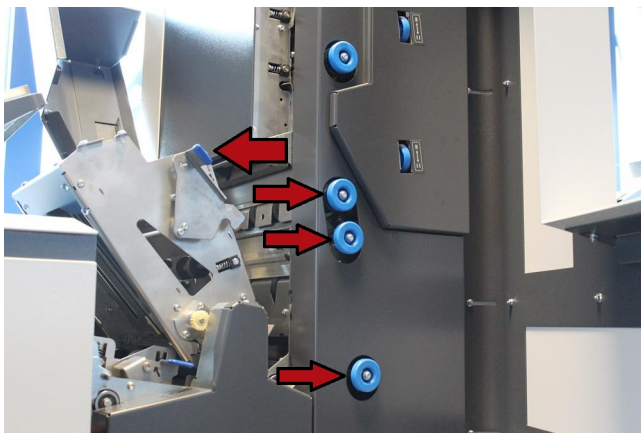

Tower Unit

Using the release handle, open the top cover to access the jammed paper.

If the paper is not fully visible, turn the blue knobs to wind it into view.

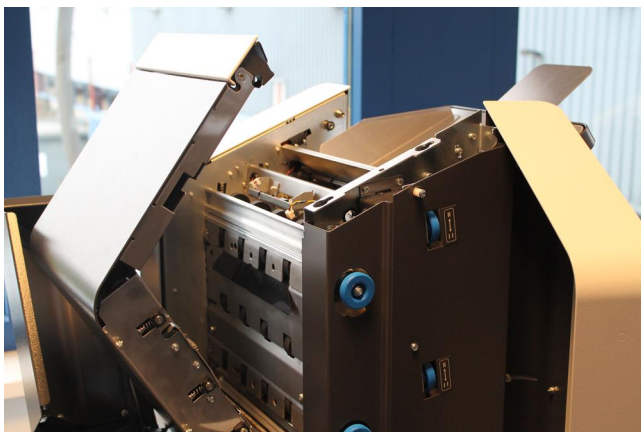

Maintaining the Wetter System

The Wetter system is supplied with sealing fluid:

- A 10-litre bottle of fluid is located in the stand and the tank is refilled automatically by a pump.

Periodically, the wetter felt should be cleaned.

Open the side cover and withdraw the wetter tank by lifting the blue tab slightly and pulling out the tank. **Use a piece of absorbent material under the drain tube to catch any drips.**

Clean off any gum residues using a damp, lint-free cloth or stiff brush. If the wetter felt is excessively worn and is not wetting the envelope flaps properly, it must be replaced.

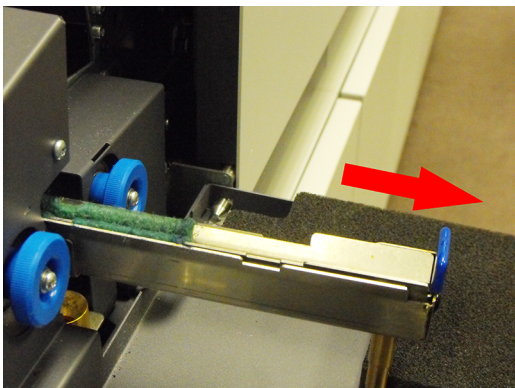

Changing the jerrycan

The system uses a 10-litre jerrycan of Envelope Sealing Fluid located in the stand below the Insert Head. When the fluid has run out, open the door and lift out the jerrycan. Unscrew the top and withdraw the pipe. Fit the top back on to the new jerrycan and replace in the stand.



10 Technical Specification

Inserter head

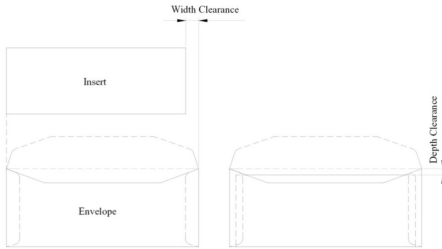
Parameters	
Pack thickness	<p>Maximum pack thickness is defined as the internal dimension of a rigid opening that a filled envelope will fall through under its own weight.</p> <p>All envelope sizes: up to 6mm (1/4")</p>
Pack clearance	<p>The minimum clearances required between the inserts and envelopes are dependent on insert pack thickness.</p> <p>Clearance is the total clearance and is defined as the difference between the largest overall dimensions of the pack and the internal dimensions of the envelope (see below). The required clearances are summarised as follows:</p> <p>Pack <3mm: Depth 6mm (1/4") Width 16mm (5/8") Pack >3mm <6mm: Depth 12mm (1/2") Width 19mm (3/4")</p>  <p>The diagram illustrates the clearance requirements. It shows a rectangular 'Insert' placed above a 'Envelope'. A vertical double-headed arrow between the top of the insert and the top of the envelope is labeled 'Width Clearance'. Another vertical double-headed arrow between the bottom of the insert and the bottom of the envelope is labeled 'Depth Clearance'.</p>
Cycling speed	<p>+%\$(: Up to 4,500 envelopes per hour (based on 1 x A4 folded sheet into a C6/5 envelope).</p> <p>+%\$(d i g Prod. Pack: Up to 5,500 envelopes per hour (based on 1 x A4 folded sheet into a C6/5 envelope).</p> <p>Speeds for other conditions available on request.</p>
Monthly volume	<p>+%\$(: Up to 180,000 filled envelopes per month.</p>
Envelope Hopper Capacity	<p>Up to 800 of 90gsm (24lbs bond)</p>

Envelope weight	Minimum: 70gsm (18lbs bond) Maximum: 100gsm (28lbs bond)
General envelope requirements	<ul style="list-style-type: none"> • Envelope to be good quality machine-fill type. Dimensions and quality to be consistent across manufactured batches. • Side seams must be securely glued to the top of the seam. • Flap crease must be pre-scored to enable the envelope flap to open flat. • No glue seepage must be evident on interior or exterior of envelope. • Windows to be securely affixed to within 1.5mm (1/16") of top and side edges. Top edge to be flat and free from puckering.
Receiving tray capacity (optional)	Up to 300 filled envelopes (assumes 1 document inserted)

Envelope details

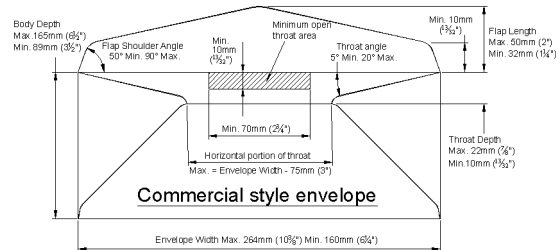
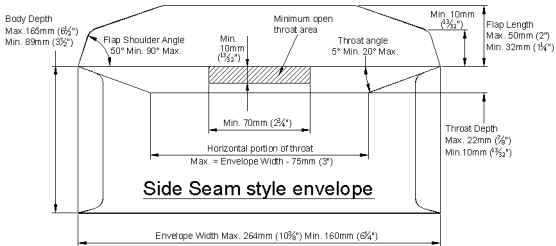

Note: Widths from 160mm to 182mm require the Narrow Envelope Kit A0023968. With the Narrow Envelope Kit fitted, the width specification is 160mm to 264mm.

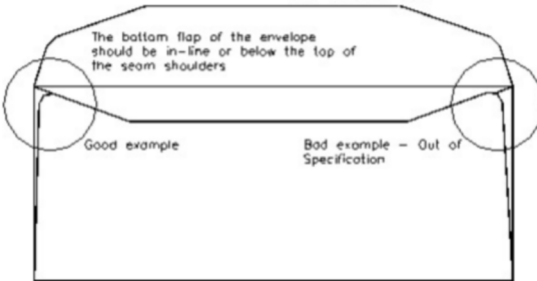
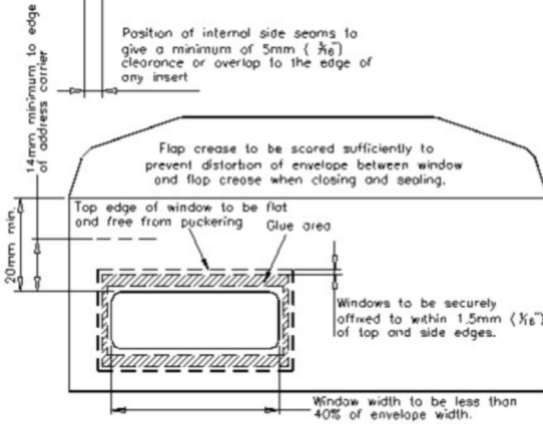
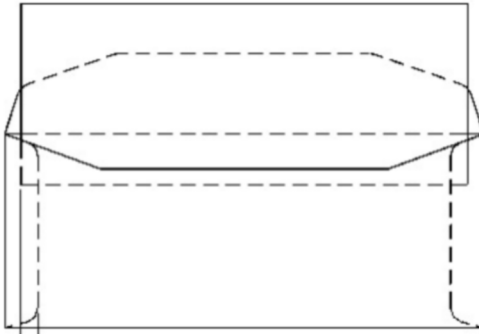

Maximum distortion allowable on a twisted envelope to be 10mm (3/8") when envelope measured sitting flat on a table.

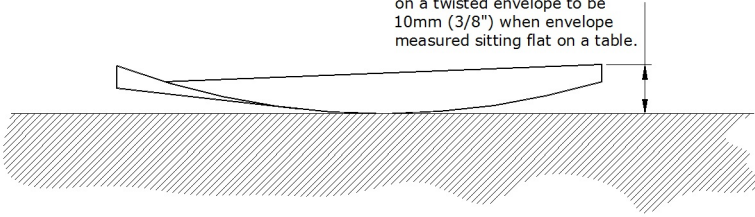

Envelope sealing fluid	Built-in wetter tank, automatically pump-fed by 10-litre jerrycan located in stand. Optional low-level float switch available.
-------------------------------	--------------------------------------------------------------------------------------------------------------------------------

Tower Folder

Parameters	
Paper Size	<p>Minimum width: 140mm (5½") Maximum width: 228mm (9") Minimum length: 140mm (5½") Maximum length: 406mm (16")</p> <p>Note: The maximum suggested width difference between inserts is 32mm (1¼"); this may be increased subject to test. If this difference is exceeded, the insertion fingers will not cover the edges of the narrow insert and may cause insertion problems. Sandwiching a narrow insert between two wider ones may resolve this.</p>
Paper weight	<p>Minimum 60gsm (16lbs bond) Maximum 120gsm (32lbs bond) for folded documents Maximum 4mm thick for unfolded inserts (subject to test)</p>

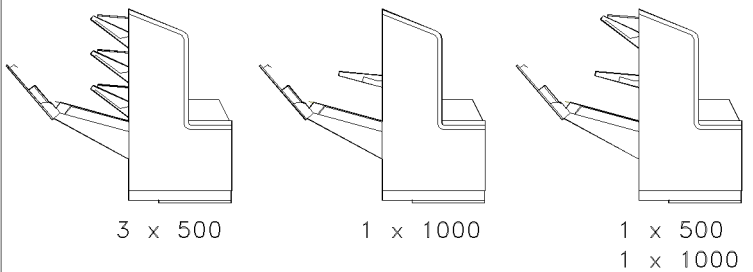
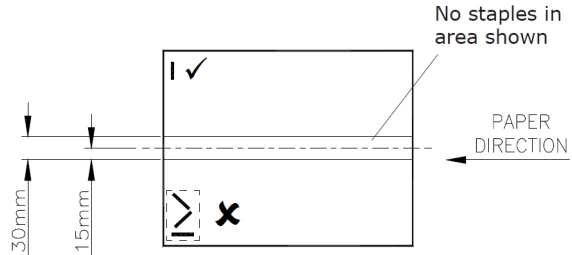
<p>Folding capacity</p>	<p>C, Z or V-fold: 8 sheets 80gsm (20lbs bond)* Double-forward fold: 4 sheets 80gsm (20lbs bond)* * Up to 2 x 8 split sets into one envelope dependent upon pack thickness.</p>
<p>Fold lengths</p>	<p>Fold Plate 1: 229mm Max, 48mm Min. Fold Plate 2: 229mm Max, 50mm Min. Fold Plate 3: 202mm Max, 50mm Min.</p>
<p>Hopper capacity</p>	<p>Tower Folder can be ordered in 3 configurations as follows: 3 x 500 sheets of 80gsm (20lbs bond) 1 x 1000 sheets of 80gsm (20lbs bond) 1 x 500 + 1 x 1000 sheets of 80gsm (20lbs bond)</p>  <p style="text-align: center;"> 3 x 500 1 x 1000 1 x 500 1 x 1000 </p>
<p>Daily mail</p>	<p>Up to 8 sheets of 80gsm (20lbs bond) for C, Z or V fold, up to 4 sheets of 80gsm (20lbs bond) for double forward fold. May be stapled or not. Max. thickness of staple 3mm. Allowable staple positions are shown below.</p>  <p style="text-align: right;">No staples in area shown</p> <p style="text-align: right;">PAPER DIRECTION</p>

Insert Feeder (Single, Twin & Reading)

Parameter	
Insert Sizes (Single Feeder)	<p>Minimum width: 140mm (5½")*</p> <p>Maximum width: 241mm (9½")</p> <p>Minimum length: 76mm (3") for module 1; 89mm (3½") for following modules</p> <p>Maximum length: 152mm (6")</p> <p>*For individual items. Min. pack width: 210mm (8¼")</p>
Paper weight (Single/Reading Feeder)	<p>Minimum 60gsm (16lbs bond) min.</p> <p>Maximum 4mm (5/32") thickness</p>
Hopper capacity	<p>Up to 300 BREs or 150 2mm booklets</p> <p>Note: Quantities shown above are maxima. Depending upon other conditions, actual quantities may be lower than those shown.</p>
Insert Sizes (Twin Feeder)	<p>Minimum width: 140mm (5½")*</p> <p>Maximum width: 241mm (9½")</p> <p>Minimum length: 76mm (3") for module 1; 89mm (3½") for following modules</p> <p>Maximum length: 152mm (6")</p> <p>*For individual items. Min. pack width: 210mm (8¼")</p>
Paper weight (Twin Feeder)	<p>Minimum 60gsm (16lbs bond) min.</p> <p>Maximum 2mm (5/64") thickness (top tray)</p> <p>Maximum 4mm (5/32") thickness (lower tray)</p>
Hopper capacity	<p>Up to 200 BREs or 100 2mm booklets</p> <p>Note: Quantities shown above are maxima. Depending upon other conditions, actual quantities may be lower than those shown.</p>
Requirements	<p>Enclosures must be flexible enough to suit path constraints.</p> <p>Some enclosures may require special tyres.</p>

Feeder Folder

Parameters	
Depth:	140mm (5 1/2") min. (89mm (3 1/2") for unfolded inserts) 406mm (16") max. (139mm (5 1/2") for unfolded inserts)
Width:	140mm (5 1/2") min. (Widths below 168mm (6.6") require narrow envelope kit A0023968). 229mm (9") max.
Thickness:	60gsm (16lbs bond) min. 70gsm (18lbs bond) min. for OMR/Barcode paper 120gsm (32lbs bond) max.
Depth of output doc:	89mm (3 1/2") min. 152mm (6") max.
Hopper capacity:	Up to 500 sheets of 80gsm (20lbs bond)
Daily Mail:	<p>Up to 3 sheets (C or Z fold) or 5 sheets (V fold) of 80gsm (20lbs bond). May be stapled or not, but staples on 'Z' fold only. Max. thickness of staple 2mm. Allowable staple positions shown below. Note: all daily mail forms must be the same length.</p> <p>Note: Daily Mail is not available as an option if a CIS reader is fitted.</p>

10

English

Mechanical & Electrical

Noise level: <73dbA (following ISO 11202).

Power Requirement and Voltage Tolerance:

230V / 50 Hz (voltage tolerance +10%/10%); 115V / 50/60 Hz (voltage tolerance +6%/10%)

Operating Temperature:

10 - 40 deg C (50 - 104 deg F)

Operating humidity:

30 - 80% RH

Electrical:

	230VAC	115VAC
Frequency	50Hz	60Hz
Input Current	Head: 1A	Head: 2A
	Single Feeder: 0.5A	Single Feeder: 1A
	Twin Feeder: 0.5A	Twin Feeder: 1A
	CIS Feeder: 0.5A	CIS Feeder: 1A
	Tower Folder: 1A	Tower Folder: 2A
	PC & Monitor: 1.2A	PC & Monitor: 2.4A

Display Properties:

Screen Size:	22"
Screen Resolution:	1920 x 1080 pixels, full HD
Screen Technology:	Full Color Touch Screen

Processing Speed:

Machine	
7104	4,500 filled envelopes per hour.
7104 plus Productivity Pack	5,500 filled envelopes per hour.

Dimensions and weight

Module	Depth (mm)	Width (mm)	Height (mm)	Weight (kg)
Inserter head (excl. monitor)	471	1063	612	80
Inserter head (incl. monitor)	525	-	812	-
Single Feeder	471	408	514	28
Reading Feeder	471	408	554	34
Twin Feeder	471	408	695	43
Feeder / Folder	471	408	710	45
Tower Folder	471	875	917	92

Ambient light

Although the machine may operate in sunlight, it is not designed for use in direct sunlight, or where sunlight is exposed to the machine through windows or skylights. The light-sensitive sensors can be affected in these conditions. It is therefore recommended to:

1. Locate the machine out of direct sunlight
2. Protect the machine from direct sunlight using blinds or similar blocking devices.

If the machine can only be located where it may be exposed to direct sunlight, then please contact Technical Support department, who may be able to advise on the use of blocking material on the inside of the Perspex cover where necessary.



1. All stationery should be allowed to acclimatise near the machine for at least 24 hours before use to prevent rapid absorption of moisture in the material, or condensation forming on the machine. Failure to acclimatise the material may cause pre-gumming of envelopes or otherwise impair machine performance.
2. The machine will function with humidity levels lower than 30% RH, but high levels of static may be generated, impairing machine performance.
3. The machine will function with humidity levels higher than 80% RH, but moisture absorption into the material may impair machine performance.
4. Condensation must not be present under any circumstances.
5. The machine will function at temperature levels above 28 deg C (82 deg F) and below 18 deg C (64 deg F). However, temperature levels outside these limits may impair the machine performance.
6. Material processed directly from laser printers may have high levels of static causing material to stick together. If double feeding occurs, then Hi-Grip separators may be required - contact IPSS department.

11 Glossary of terms

Glossary of terms

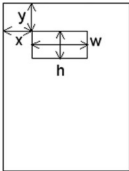
Term	Description
Address carrier	<p>The address carrier is the document that carries the address of the person for who the mail set is meant. The address carrier can consist of one or more sheets, from which at least the first sheet must contain the address. The address must remain visible while enclosures are added and the document set is folded. The fold type and selected envelope must ensure that the address is visible behind the window in the envelope. For personalized mailings there is always an address carrier present as long as envelope printing is not supported. Normally there is one address carrier.</p>
Address position	 <p>Position of the address on the address carrier, measured from the upper left corner. The address position consists of a horizontal x coordinate, a vertical y coordinate, a horizontal width w and a vertical height h.</p>
Automatic	<p>The feature of an inserting system to automatically determine its job settings by measuring the sizes of documents and envelope. From all feeders that are loaded one sheet will be taken. Based on the maximum document length (which is also the length of the document set) and the length of the envelope the fold type is determined.</p>

Automatic job	A job that is created with the Automatic job functionality.
Barcode Reading (BCR)	Barcode Reading is intended for reading and interpreting printed barcodes. The codes give information to the inserting system about how to build-up and handle a set.
Business Reply Envelope (BRE)	Envelope included in outgoing mail sets for addressee response purposes.
Cascading	See Feeder linking.
C-fold	See Letter fold.
Daily Mail	Capability of an inserting system to manually insert mail sets one by one into the system, which are then inserted into an envelope. Optionally, depending on settings, additional enclosures can be added and the mail set can be folded. This function is intended for small amounts of mail that each can have a different build-up.
Deskew	A system of straightening a skewed document or enclosure by driving it into a set of drive rollers that have been briefly stopped. This removes the skew, and after a set period of time, the rollers restart. Deskew slows the machine down and can be disabled or adjusted for amount of deskew for forms that are not prone to skewing.
Document	A document is one of the components of a mail set. A document can consist of one or more sheets. Documents can be divided into address carriers and enclosures. For personalized mailings there is always one address carrier and an optional number of enclosures.

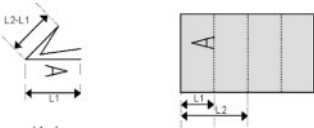
Document set	<p>The document set is the physical collection of address carrier and enclosure(s) that is under production in the inserting system. The document set is completed during production and is to be inserted into the envelope. The number of enclosures can range from 0 to the limit imposed by the number of available feeders, whilst observing the overall pack thickness. Once the document set has been inserted into an envelope it is called mail set.</p>
Double Document Detection	<p>Double Document Detection is the sensor that measures the thickness of a sheet to check if the inserting system does not accidentally take more sheets than intended. DD sensors exist on feeders (double sheet detection). Currently DD detection on Neopost inserting systems perform relative measurements, which means that they need a cycle to 'learn' the thickness of a sheet. Also the length of the document is measured so partly overlapping sheets will be detected.</p>
Double parallel fold	<p>The double parallel fold is a type of fold where the document is first folded halfway and the resulting folded set is again folded halfway. This fold is illustrated in the picture below. The position of both folds is adjustable.</p> 
Envelope	<p>The envelope is the packaging of a mail set. Window envelopes are envelopes that have a transparent section through which the address on the address carrier can be read. Besides the normal top closing window envelopes there are also bottom closing envelopes.</p>
Face down	<p>Situation in which the front of a sheet is facing downwards when placed in a document feeder.</p>

Face down leading	Situation in which the front of a sheet is facing downwards and the top of the sheet is closest to the separation unit in a document feeder, ie. the front end of the tray
Face down trailing	Situation in which the front of a sheet is facing downwards and the bottom of the sheet is closest to the separation unit in a document feeder, ie. the front end of the tray.
Face up	Situation in which the front of a sheet is facing upwards when placed in a document feeder.
Face up leading	Situation in which the front of a sheet is facing upwards and the top of the sheet is closest to the separation unit in a document feeder, ie. the front end of the tray.
Face up trailing	Situation in which the front of a sheet is facing upwards and the bottom of the sheet is closest to the separation unit in a document feeder, ie. the front end of the tray.
Feeder	A feeder is a module for the input of documents to the inserting system. The feeder separates documents sheet by sheet from the stack of documents in the feeder tray.
Feeder linking (Cascading)	The ability to load two feeders with the same document type where the inserting system automatically switches to a second feeder when the first feeder is empty and vice versa. In the mean time the first feeder can be refilled, so the inserting system can keep running without having to stop for refilling the feeders.
Feeder tray	Part of the feeder that contains the stack of documents or envelopes.
Flexcode OMR	An OMR code for which the meaning of the OMR marks can be programmed in a dedicated way for a specific customer. This is normally used to support the OMR codes from other suppliers

FlexFeed	The flexFeed is the feeding part of the system.
High Capacity Feeder	Feeder that has a capacity up to 1000 sheets (on a Tower Folder).
Insert	<ul style="list-style-type: none"> • To insert is the action of inserting a document set into an envelope. • For native English speaking customers an insert is also a short document, not to be folded, usually an enclosure.
Insertter	An inserter is the module where the document set is inserted into the envelope, the envelope is closed and if necessary sealed.
Inserting system	The system of all the modules that cooperate to perform the inserting function (accumulate document set, fold and insert) and have a single point of control.
InsertnFrank™ (mailing system)	Interface for the Neopost franking system.
Job	<p>A job is an actually produced collection of mail sets based on a certain job definition at a certain point in time for a specific purpose. It consists of:</p> <ul style="list-style-type: none"> • The job definition used for the production • Information about the batch size
Job counter	The counter that registers the number of mail sets that is produced as part of a specific job.
Letter fold (also known as C-fold)	Fold type in which a document set is folded twice in which the folded flaps are on top of each other. This fold is illustrated below. The position of both folds is adjustable.
Linking	See Cascade
MaxiFeeder	Feeder with high capacity feeder tray.
Multiples	The feature of an inserting system in which more than one sheet is taken from a feeder.
OMR	Optical Mark Recognition (see further table entry).

OMR code definition	Standard 1-track OMR code definition. Specifies the amount of reading marks used and the functionality linked to each of them (how each should be interpreted). A definition is a licensed option.
Operator	The person operating an inserting system.
Optical Mark Recognition (OMR)	Optical Mark Recognition is intended for reading and interpreting printed codes. These codes are one or more black marks which are read from a document. These marks give information to the inserting system about how to build-up and handle a set.
Output Conveyor	Fitted at the output for filled envelopes to be ejected onto. Higher capacity alternative to a receiving tray. 2 lengths are available.
Pod/Tower Unit	The feed hopper unit fitted to a Tower Folder. Available with either 3 x 500-sheet trays, 1 x 500-sheet + 1 x 1000-sheet trays or 1 x 1000-sheet tray.
Reading error	Condition in which the system could not reliably read or interpret the OMR reading marks or barcode from a sheet.
Reading marks	Marks added to documents containing finishing instructions that can be identified by an reading head and interpreted according to the used OMR code definition.
Receiving tray	Fitted at the output for filled envelopes to be ejected into. Basic alternative to an Output Conveyor.
Remote diagnostics	The feature that makes it is possible to analyze a problem on an inserting system from a remote location.
Service engineer	Technical engineer whose task it is to resolve problems with systems in the field. Besides dealing with problems, service engineers are also responsible for preventive maintenance.

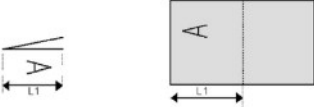
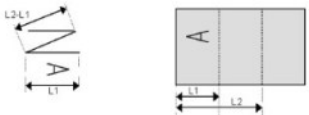
Single fold	<p>A single fold implies the document set is folded once. The fold position is adjustable. This fold is illustrated below:</p> 
Stop counter	Counter which sets the amount of envelopes to be filled. After filling this amount of envelopes the system will stop.
Supervisor	Person who is responsible for the technical state of the system. Normally a supervisor has access to programming functions, which are restricted for standard users.
Test run	<p>A test run is intended to validate the settings of the inserting system:</p> <ul style="list-style-type: none"> • Inspect and adjust the stop position of the envelope. • Check the fold settings for one set. • Check whether the address is correctly positioned behind the envelope window.
Tray (or hopper)	Contains a stack of paper for a printer or inserter. This paper is supplied to the system for further processing.
Vertical transport	The vertical transport section between hoppers and folder/ collator below .
Z-fold (also known as zigzag fold)	<p>A Z-fold means that a document is folded twice in such a way that each folded flap is on a different side of the folded document, resulting in a Z-shape. This fold is illustrated below.</p> <p>The position of both folds is adjustable.</p> 

12 INF Output Conveyor appendix

Introduction

Introduction

With this conveyor you have an output device intended for use with a F61 Series folder/inserter. It provides a means of receiving filled envelopes and turning certain sizes through 90° in order to correctly orientate them for subsequent franking operation: this is mainly applicable to C4 envelopes, and C5 with vertical windows. Its operation is programmed within IMOS and is job-specific.

In order to ensure the long usage of this machine and its components, and above all the safe use of the machine, you must read and adhere to the operating instructions and safety notes. Always be aware of all warnings and notes that are mounted or noted on the machine itself.

All persons entrusted with the handling of this machine must also be familiar with the operating manual. Save this handbook carefully, so that the information it contains may be available at all times.

Description of machine

Machine options

The function of the INF Output Sorter is to receive mailpieces from a F61 Series folder/inserter and direct them to two or more output paths, eg. Output Conveyors.

Sorter – Up to 2 Sorters can be fitted with 3 Output Conveyors.

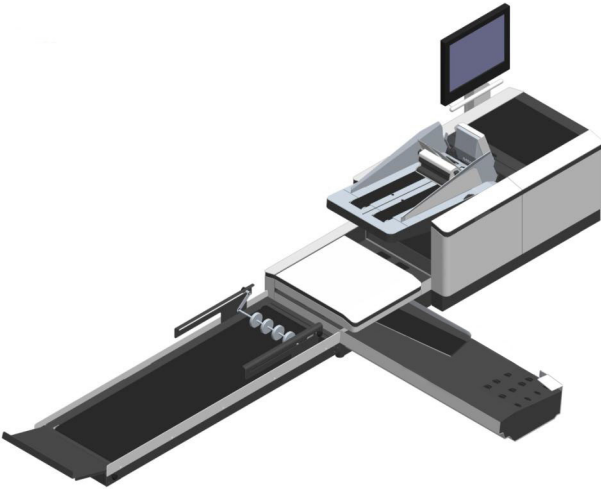
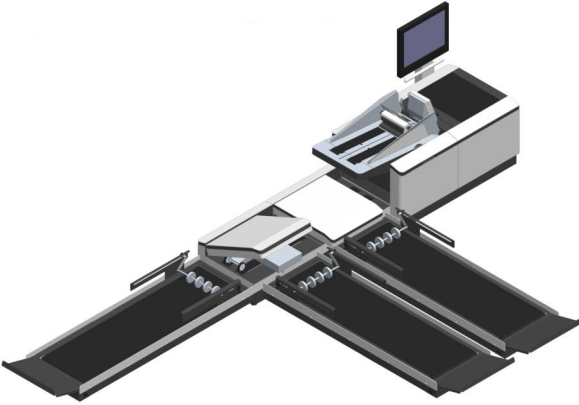

12

English

12

English

Sorter adjustments

Catch Tray

The Sorter can be optionally fitted with a catch tray at either exit. This receives the envelopes in a stack to allow subsequent hand removal. It is adjustable to suit a variety of envelope

Adjust backrest to allow envelopes to stack neatly.
Tilt the backrest forward to adjust.

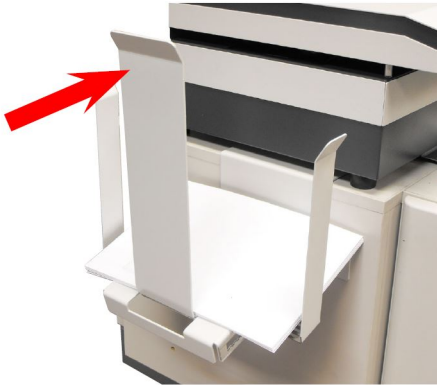

Slacken thumb-screws below and move side guides to provide 6-8mm clearance each side.

Tighten screws when adjustment is complete.

Mail Sorting

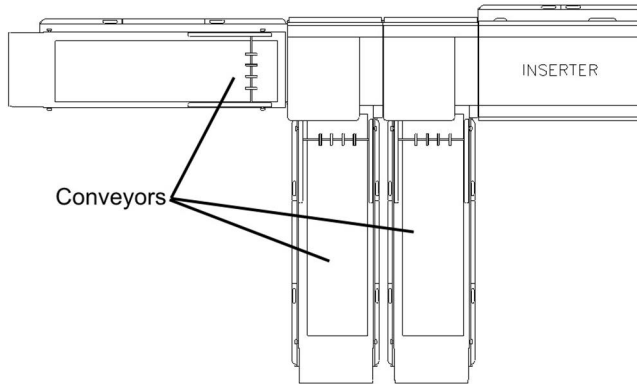

Mail sorting allows weight groups to be defined and added to a numbered **Mail Sort**, which can then be directed to a particular exit. It applies only when one or more sorters are fitted, which may optionally also be fitted with 1 or 2 conveyors.

A Mail Sort is part of the **Postal Product** and is a set of criteria that determines how the mail pieces within it are treated when they reach the sorter. The criteria are the Weight Group and Exit Selection OMR mark (or BCR character): these two criteria use a priority basis to determine the exit at the sorter.

In addition to weight groups, an **Exit Selection** mark or character can be used to differentiate Mail Sorts. If weight groups are being used, these must first be defined and named in a **Postal Product**. This is carried out in the Menu screen.

The example below shows the maximum configuration of 2 sorters and 3 output conveyors.

Postal Products

1. Select **Postal Products** in the Menu screen.

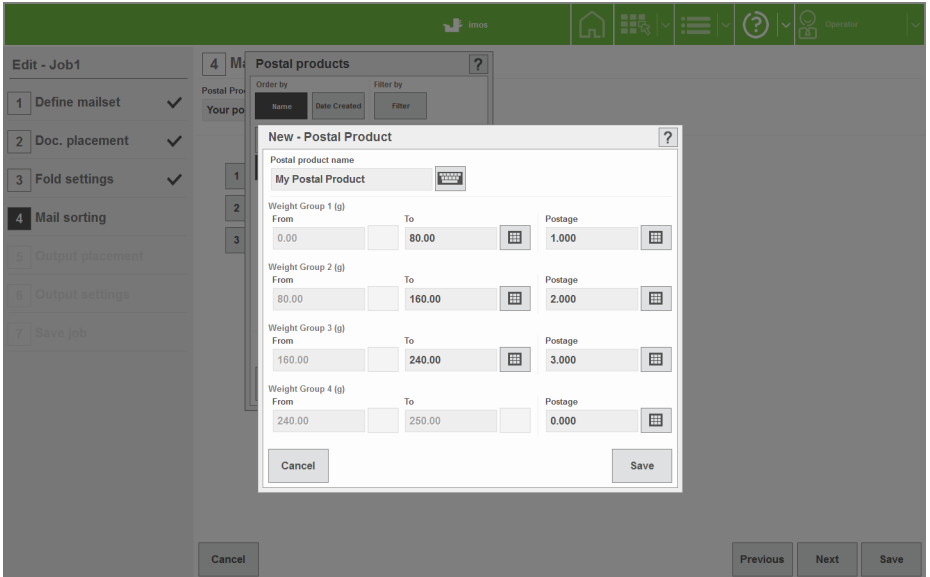

2. Select **Create New** (or **Edit** for an existing Postal Product).
3. Set the weight groups as required - note that the minimum weight of each group is the same as the maximum weight of the previous group.



The Postal Product list can be ordered by Name or Date Created.

12

Mail Sorts

1. In the **Mail Sorting** part of the Output Settings screen, select the Mail Sorting button.

English

2. Select options as described on the following page.
3. Select the Postal Product defined in step 1 of "Postal Product".
4. Select the Sort Criteria, and then the required Mail Sort associated with it (by default, the last Mail Sort selected will be used).
5. Set the priority required for each line. As each Mail Sort can have a number of combinations of criteria, some of which may overlap, you can determine which has priority.

The example above shows Weight Group 1 and Exit Selection marks 1 & 2 are all contained in Mail Sort 2; you could change the priority so that mailpieces with Exit Selection Mark 1 have priority over those in Weight Group 2 instead of the priority they currently have.

Select any priority number to switch on the scroll arrows. After making changes, select a number again to switch them off.

Select **Save** when you have finished: your Sort Settings are now saved to the Postal Product.

6. If Batching is being used, select the **Settings** button.

Batching for Sorted Mail is the same as for Unsorted Mail, described in [Output settings](#).

Output Placement

Imos

Operator

Edit - Job1

5 Output placement

Auto place mail sorts

1 Define mailset ✓

2 Doc. placement ✓

3 Fold settings ✓

4 Mail sorting ✓

5 Output placement

6 Output settings

7 Save job

Unsorted mail

EMS

Exit 2

Exit 1

Mail sort 2

Mail sort 1

Cancel

Previous

Next

Save



Your settings may be different from those shown here, depending upon the hardware fitted.

Output Placement allows you to determine which exit each Mail Sort is directed to.

1. Select the Output Placement button in the Output Settings screen.
2. To change a Mail Sort (or Unsorted Mail) from one exit to a different one, select it, then select the new position. If you want to reset your changes to the default position, select **Auto place mail sorts**.

Output Settings are now complete.

Output settings



See also the chapter "[Creating a job](#) on page 32" for full details of creating/editing a job.

The Output Settings in the job control how the INF Output Sorter is used. The settings are defined when the job is created, or can be added or changed later by editing the job.

Output settings are described below and assume that the envelope, document and enclosures have already been set up.

1. Select **Settings** for Unsorted Mail in the Output Settings screen.

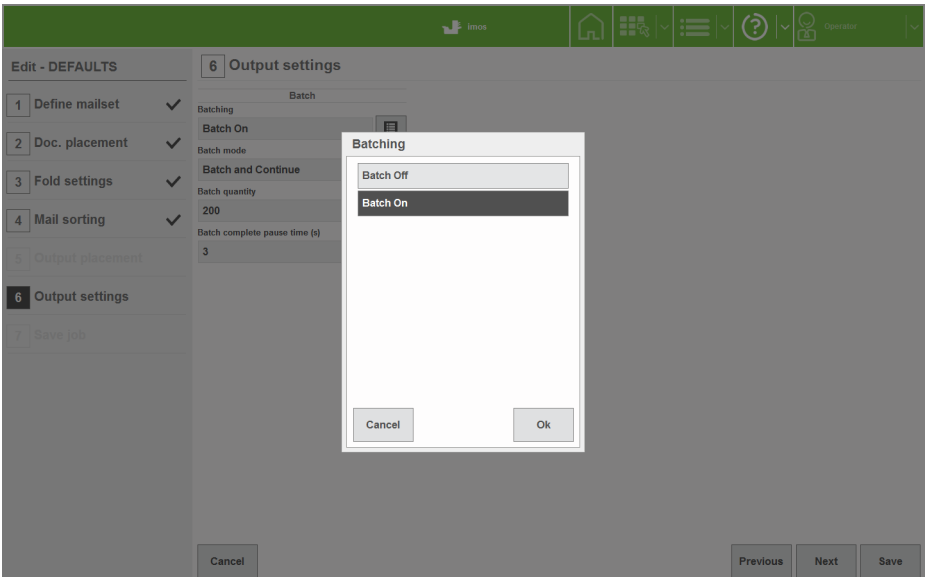

2. Set **Batching** to **Batch On** if required and set required quantity in **Batch Quantity**.

Set **Batch Mode** as follows:

- **Batch and Continue:** Machine will pause for the specified pause time, and then resume.
Note: conveyor will continue to run during the pause time.
- **Batch and Stop:** Machine will stop and resume only when the Run button is pressed.

Select **Envelope Count** under **Batch Control**, currently the only available option.

Set the **Batch Complete Pause Time** as described in **Batch and Continue** above.

When settings are complete, press the **Save** button.

3. If a conveyor is fitted, select **Conveyor Settings** to adjust the Jog functions as follows:

- **Single Jog Adjust:** Adjusts default jog step (gap) between mailpieces. Note that steps are unitless.
- **Batch Complete Jog Step:** Adjusts gap before machine performs action described in 'Batch Mode'.
- **Mark Reading Jog Step:** Adjusts gap created after Jog mark is read.
- **Autoend Jog Step:** Adjusts gap created before machine autoends.

When settings are complete, press the **Save** button.

Batch		Conveyor settings	
Batching	Batch Off	Single jog adjust	0
Batch mode	Batch and Continue	Batch complete jog step	10
Batch quantity	200	Mark reading jog step	10
Batch complete pause time (s)	3	Autoend jog step	30

Output Settings for unsorted mail is now complete. If you are using Mail Sorting, see Mail Sorting.

12

English

Operator Maintenance

Cleaning Sensors

The machine uses optical sensors to track the movement of mailpieces along the paper path. These sensors must be regularly cleaned to prevent false readings.

The sensors are in 2 halves, upper and lower: both halves must be cleaned. They are fitted only to the Sorter; locations are indicated below. Use a non-flammable airduster (part number 9103707C), spraying liberally onto each lens – direct the nozzle upwards for the upper half.

Cleaning the conveyor belt

Staining or soiling of the conveyor belts on the INF Conveyor and Sorter may occur after a long period of use. To clean the belts, a lint-free cloth dampened with water will normally be sufficient. For more stubborn soiling, a foam-type surface cleaner can also be used.



To avoid damaging the belts, do not use strong, spirit-based cleaners.

Technical Specification

Physical sizes

O/A Sizes:	1600mm (63")	Length (including backrest)
	420mm (16½")	Width
	435mm (17")	Height
Weight:	25.5Kgs (56lbs)	
Speed:	4m/minute Max. Linear Speed (controlled by inserter)	
	Selectable jog function for batching.	

Electrical

Electrical	Voltage:	24VDC (supplied via DIN lead from inserter)
Rating:	Power:	12W Max.
	Fuse:	N/A

Troubleshooting Guide

Troubleshooting Guide

If operating problems cannot be resolved using the following guide, the Technical Department must be contacted for further assistance.

PROBLEM	SUGGESTED CAUSE AND REMEDY
2. INF Conveyor is not moving.	2. Check DIN lead is properly connected to inserter.

3. Envelopes failing to contact datum edge side-guide and failing to turn when they should.	3. Perspex backstop is set too far away to allow sufficient 'bounce-back' (INF Conveyor adjustments).
4. Envelopes failing to turn properly.	4. a) Ensure adjustable panel is lowered when turning envelopes (INF Conveyor adjustments). b) Clean conveyor belt surface (Cleaning the conveyor belt).
5. Envelopes ejecting from wrong exit.	5. Ensure exit is allocated correctly in Output Placement .
6. Envelopes with unexpected Sort Criteria are exiting.	6. Ensure 'Priority' is correctly set in Edit - Sort Settings dialog (Mail Sorting).
7. Envelopes failing to leave Sorter properly.	7. Clean conveyor belt surface (Cleaning the conveyor belt).